



Mosaic[®]

Design & Installation Guidelines

Welcome

Welcome to the VERSA-LOK Mosaic Retaining Wall System Design and Installation Guidelines.

Welcome to the VERSA-LOK® Mosaic® Retaining Wall System Design and Installation Guidelines.

This guide applies to both the Mosaic system and its individual units. The Mosaic system comprises three retaining wall units: VERSA-LOK Standard, VERSA-LOK Accent®, and VERSA-LOK Cobble®. Although each is an integral part of the Mosaic system, each can stand on its own as a separate-entity retaining wall system. However, there are many variables to consider when planning or constructing any retaining wall. Soil types, drainage, loading, topography and height need to be addressed on each project to ensure safe, trouble-free installation.

Please note the maximum height for an unreinforced Mosaic retaining wall is 4 feet. Individual site, soil and loading conditions (including terraces) may limit unreinforced wall heights to less than 4 feet. Taller walls require soil reinforcement and engineering assistance.

In addition to this guide, VERSA-LOK offers a variety of technical support, including in-house engineering assistance and reference literature. Please call (800) 770-4525 with questions about Mosaic, Accent or Cobble Retaining Wall Systems, or to request additional literature.

The following technical materials were written for use of VERSA-LOK Standard units; however, the general principles apply to Mosaic walls as well. You also can download Technical Bulletins from the VERSA-LOK website at www.versa-lok.com

- **Technical Bulletin #1**
Shoreline, Waterway and Retention Pond Protection
- **Technical Bulletin #2**
VERSA-LOK Stairs
- **Technical Bulletin #3**
Curves and Corners
- **Technical Bulletin #4**
VERSA-LOK Caps
- **Technical Bulletin #5**
Base Installation
- **Technical Bulletin #6**
Freestanding and Vertical Walls
- **Technical Bulletin #7**
Tiered Walls
- **Technical Bulletin #8**
Fences, Railings and Traffic Barriers
- **Design and Installation Guidelines**
- VERSA-LOK Standard
- **Technical Documentation for VERSA-Grid® Soil Reinforcement**
- **Standard and Mosaic Construction Details CD-Rom containing specifications and drawings created with AutoCAD® software**
AutoCad is a registered trademark of Autodesk, Inc.

This guide is intended to illustrate design and construction capabilities of the VERSA-LOK Mosaic Retaining Wall System. There are many variables to consider, however, when planning or constructing any segmental retaining wall. Soil types, drainage, loading, topography and height need to be addressed on every project to ensure safe, trouble-free installation.

Table of Contents

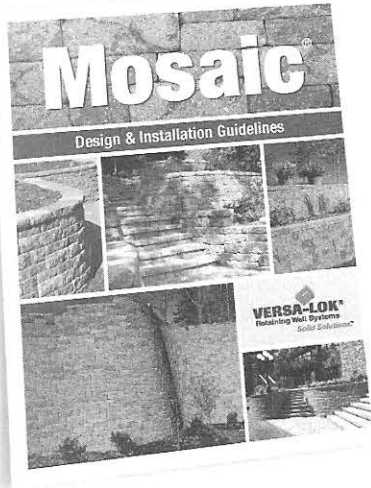

1 Introduction & Unit Specifications – Mosaic®	3
2 Mosaic System Overview	6
3 Mosaic Wall Components	7
• <i>Foundation</i>	
• <i>Embedment</i>	
• <i>Soils and Compaction</i>	
• <i>Drainage Within Walls</i>	
• <i>Surface Drainage</i>	
• <i>Geosynthetic Reinforcement</i>	
4 Special Design Considerations	10
• <i>Shorelines</i>	
• <i>Loads Behind Walls</i>	
• <i>Tiering</i>	
5 Planning, Estimating, & Final Designs	11
6 Mosaic Wall Construction	14
• <i>Tools</i>	
• <i>Unit Modification</i>	
• <i>Excavation</i>	
• <i>Leveling Pad</i>	
• <i>Base Course</i>	
• <i>Installing First Course of Panels</i>	
• <i>Pinning Mosaic Panels</i>	
• <i>Installing Additional Courses of Panels</i>	
• <i>Drainage Aggregate</i>	
• <i>Compacted Soil Backfill</i>	
• <i>Geosynthetic Soil Reinforcement</i>	
• <i>Caps</i>	
7 Basic Wall Design Elements	22
• <i>Curves, Concave (Inside) Curves, Convex (Outside) Curves</i>	
• <i>Corners</i>	
• <i>Outside 90° Corner</i>	
• <i>Outside 90° Corner - Vertical Side Wall at Stairs</i>	
• <i>Inside 90° Corners</i>	
• <i>Stepping Top of Wall</i>	
• <i>Stepping Base of Wall</i>	
8 Advanced Wall Features	28
• <i>Stairs</i>	
• <i>Fences/Railings</i>	

SUPPLEMENTAL INFORMATION

Mosaic Material Estimation Worksheet	29
VERSA-Grid® Estimation Charts	30
Cobble® Retaining Wall System	31
Accent® Retaining Wall System	31
Mosaic Specifications	32-38
Mosaic Construction Detail Drawings	39-42

This guide demonstrates the exceptional design capabilities and easy installation methods of the VERSA-LOK Mosaic Retaining Wall System.

Introduction & Unit Specifications

VERSA-LOK® Mosaic®

The VERSA-LOK Mosaic Retaining Wall System represents the ultimate combination of aesthetics and performance in segmental retaining walls.

Mosaic panels create a seemingly complex random-patterned, natural stone appearance while still providing unmatched ease in installation and design flexibility.

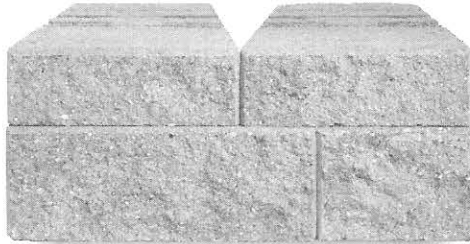

While appearing to be randomly placed in the wall, Mosaic units are installed in simple panels.

The Mosaic system utilizes VERSA-LOK units of varying heights and widths to achieve a random-like pattern that closely resembles natural stone walls. Mosaic retaining walls consist of three units: **Standard**, **Accent**®, and **Cobble**®.

One Standard, one Cobble, and two Accent units are arranged in ten-inch-high by 24-inch-wide panels. There are four different panel configurations that can be arranged in any order to form a random, natural stone wall appearance.

The Mosaic system provides design flexibility, durability, and ease of installation. VERSA-LOK Mosaic walls are quickly and economically assembled without mortar and do not require concrete footings. VERSA-LOK's unique hole-to-slot pinning system interlocks units and aids in alignment. Installers can easily modify the solid Mosaic units to create an unlimited variety of curves and corners, without ordering special units. Matching concrete cap units are available to finish any VERSA-LOK Mosaic wall.

MOSAIC PANEL CONFIGURATIONS

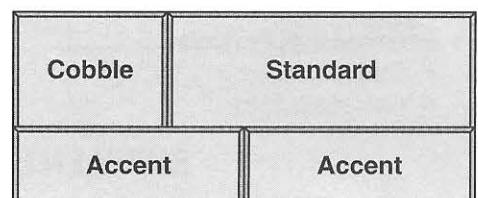
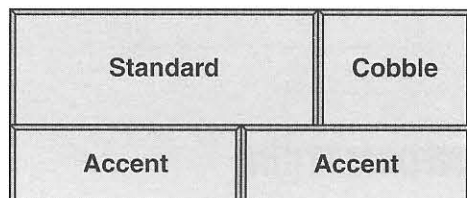
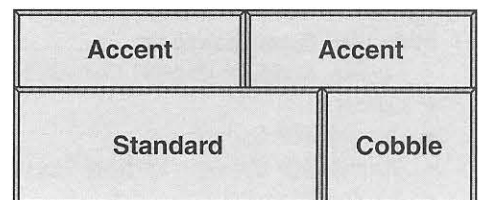
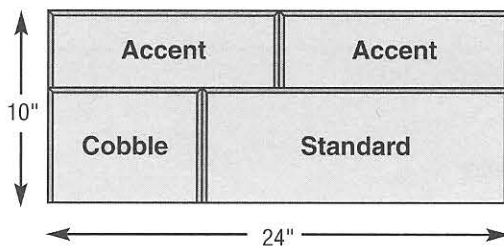

Introduction & Unit Specifications

VERSA-LOK® MOSAIC®

1

VERSA-LOK MOSAIC UNITS

(Actual unit size and weight may vary slightly by region.)

VERSA-LOK Mosaic units are made from high-strength, low-absorption concrete on concrete block machines. VERSA-LOK Mosaic units' solid characteristics make them resistant to damage before, during, and after construction in all climates, including shoreline applications.

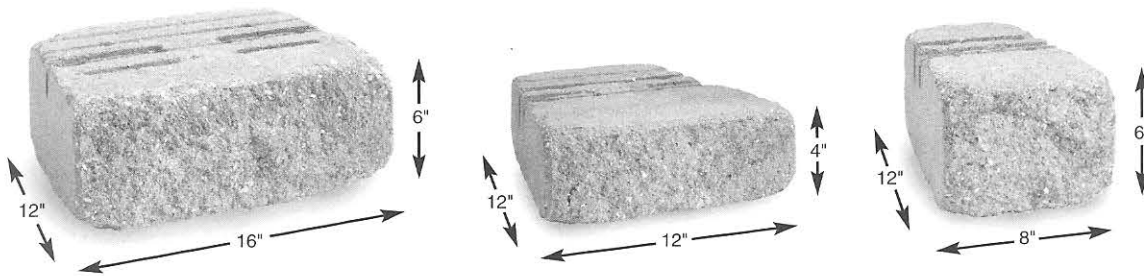

Solid
VERSA-LOK
Mosaic units
provide superior
durability and
construction
stability.

	Standard		Accent®		Cobble®	
Height:	6 inches	152.4 mm	4 inches	101.6 mm	6 inches	152.4 mm
Width (face):	16 inches	406.4 mm	12 inches	304.8 mm	8 inches	203.2 mm
Width (rear):	14 inches	355.6 mm	8 inches	203.2 mm	6 inches	152.4 mm
Depth:	12 inches	304.8 mm	12 inches	304.8 mm	12 inches	304.8 mm
Face Area:	2/3 ft ²	0.062 m ²	1/3 ft ²	0.031 m ²	1/3 ft ²	0.031 m ²
Weight:	82 lbs	37.19 kg	38 lbs	16.33 kg	38 lbs	17.24 kg
Wgt/Face Area:	123 lbs/ft ²	599.84 kg/m ²	108 lbs/ft ²	526.77 kg/m ²	114 lbs/ft ²	556.13 kg/m ²

VERSA-LOK MOSAIC WEATHERED

(Available in most areas.)

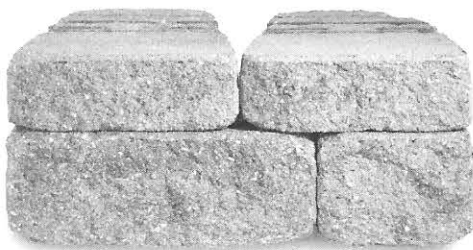

As an attractive alternative, all three Mosaic units are offered with a weathered appearance (left). Weathered™ Mosaic units undergo a special process to create a rustic old-world appearance that closely resembles natural stone.

Introduction & Unit Specifications VERSA-LOK® Mosaic®

VERSA-LOK Mosaic units have a unique hole-to-slot pin system for easy installation and superior structural integrity.

VERSA-LOK MOSAIC PINNING

VERSA-LOK Mosaic units interlock with non-corrosive VERSA-TUFF® Snap-Off Pins. VERSA-TUFF Pins are inserted through front holes in the upper units into slots in the units below. Slots allow variation in location of vertical joints (variable bond). Generally, two VERSA-TUFF Snap-Off Pins are used for each Standard, Accent®, and Cobble® unit—eight VERSA-TUFF Pins per panel.

VERSA-TUFF Snap-Off Pins are designed to accommodate varied heights of Mosaic units. The full length of VERSA-TUFF Pins is used when pinning through six-inch-high Standard and Cobble units, (Figure A). When pinning through four-inch-high Accent units, the two-inches of the VERSA-TUFF Pin remaining above the unit is easily snapped off (Figure B).

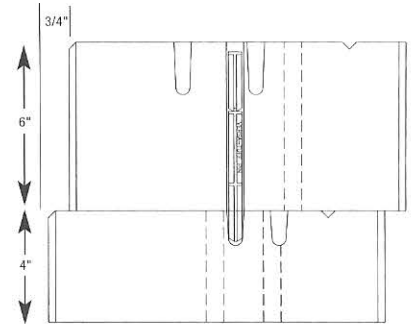

Pinning Standard/Cobble to Accent

Figure A

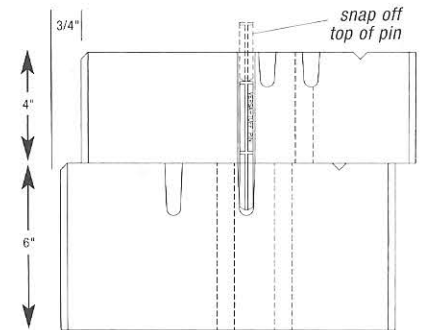

Pinning Accent to Standard/Cobble

Figure B

VERSA-TUFF® SNAP-OFF PIN

Length:	6.8 inches	172.7 mm
Snap-Off Length:	4.625 inches	117.5 mm
Diameter:	0.48 inches	12.2 mm
Material:	Glass-Reinforced Nylon	

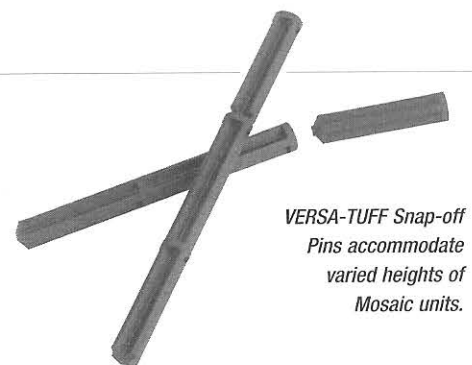

VERSA-TUFF Snap-off Pins accommodate varied heights of Mosaic units.

VERSA-LOK CAP UNITS

Weight:	A Cap	40 lbs	18.14 kg
	B Cap	50 lbs	22.68 kg

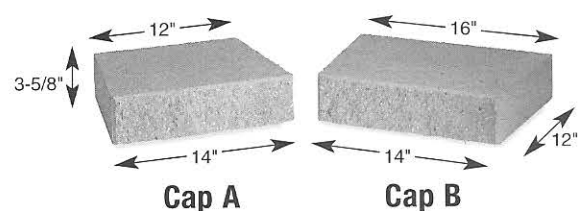

Matching cap units attractively finish VERSA-LOK walls.

VERSA-LOK[®] Mosaic[®] System Overview

2

VERSA-LOK[®] MOSAIC—TYPICAL SECTIONS

On many projects, Mosaic retaining walls work purely as gravity systems, where unit weight, frictional forces between units, pins, and the cant of the wall combine to provide resistance to earth pressures. With level backfill and no excessive loading, most Mosaic walls are stable to four feet in height.

When unit weight and frictional forces are not enough to resist soil loads, horizontal layers of geosynthetics are used to reinforce soil behind walls.

With proper design and soil reinforcement, Mosaic walls can be constructed to heights exceeding 40 feet.

Each Mosaic unit is set back 3/4-inch from the units beneath it. There are two units stacked in each ten-inch-high panel—a total setback of 1.5 inches per panel. This results in a cant of approximately 8.5 degrees from vertical.

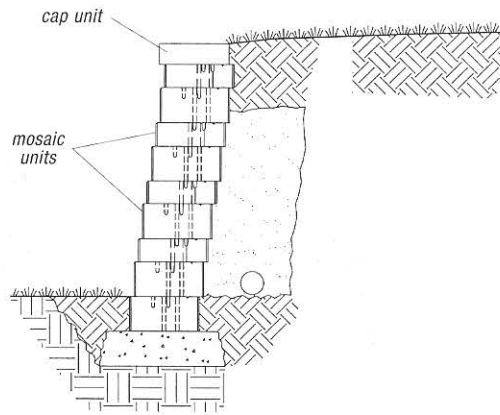

Unreinforced

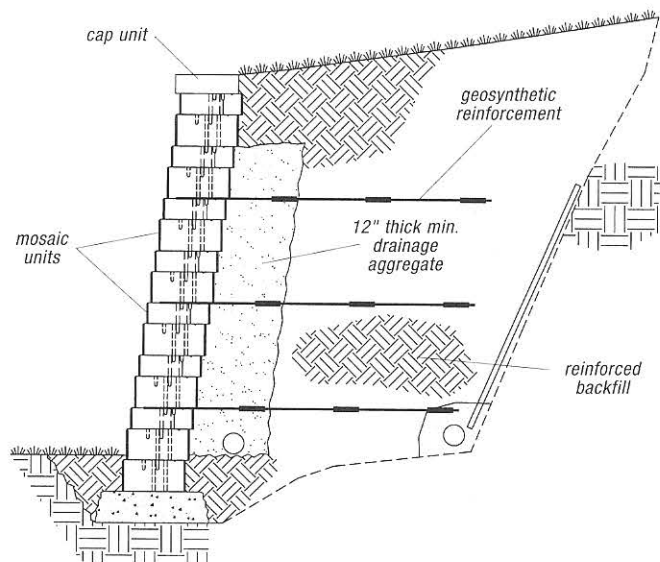

Reinforced

VERSA-LOK Mosaic's unique panel system provides level courses every ten inches to easily accommodate geogrid layers used in tall wall construction.

VERSA-LOK® Mosaic® Wall Components

*Mortarless
VERSA-LOK walls
do not require
rigid concrete
footings
below frost.*

Foundation

Foundation soils on which walls will rest must be stiff, firm, and have sufficient capacity to support wall system weight. Any loose, soft, or compressible material must be removed and replaced with properly compacted backfill. The bearing capacity of the foundation soils should be addressed by a soils engineer.

VERSA-LOK segmental retaining walls are installed on leveling pads consisting of well-graded angular gravel. The most commonly used material for leveling pads is that which is used locally as road base aggregate. Granular leveling pads provide stiff yet somewhat flexible bases to distribute wall weights.

Rigid concrete footings extending below frost are not required or recommended. Because VERSA-LOK units are installed without mortar, they are free to move slightly in relation to each other. Flexibility of the leveling pads and wall units accommodates freeze/thaw cycles without damage to structures. VERSA-LOK walls installed on granular leveling pads have been successfully used on projects throughout North America—including shoreline applications and walls exceeding 40 feet in height.

If a contractor chooses to form leveling pads using concrete, unreinforced pads should be made of lean concrete mix (200-300 psi) and no more than two inches thick. To ensure correct VERSA-LOK unit alignment, special care needs

to be taken to construct concrete pads that are exactly level. In rare situations where rigid, reinforced concrete footings are required, they should be placed below seasonal frost depths.



*Compacted granular leveling pads
provide stiff but flexible bases for
Mosaic units.*

Embedment

VERSA-LOK segmental retaining walls should have one-tenth of exposed wall heights embedded below grade. For example, a wall with 15 feet of height exposed above grade should have a minimum of 1.5 feet buried below grade—making a total wall height of 16.5 feet. Embedment should be increased for special conditions such as slope at the toe of walls, soft foundation soils, or shoreline applications. Embedment provides enhanced wall stability and long-term protection for leveling pads.

VERSA-LOK® Mosaic® Wall Components

3

Soils and Compaction

With proper design, VERSA-LOK segmental walls can be constructed within a wide variety of soil conditions. Granular soils are preferred as fill in the areas reinforced with geosynthetics; however, fine-grained soils such as clays are acceptable. Usually, coarse soils require less soil reinforcement and are easier to compact than fine soils. Problem materials like expansive clays, compressible soils, or highly organic soils (top soil) should be avoided or properly addressed in designs.

Proper compaction of foundation and backfill soil is critical to long-term performance of retaining wall systems. Loose backfill will add pressure on walls, collect water, cause settlement, and will not anchor soil reinforcement materials properly. Foundation and backfill materials should be compacted to at least 95 percent of standard Proctor density. (Proctor density is the maximum density of the soil achieved in a laboratory using a standard amount of compaction effort.) Generally, construction observation and testing for proper soil type and compaction is provided by the project's soils engineer.

Drainage Within Walls

Segmental retaining walls are designed assuming no hydrostatic pressure behind walls. Drainage aggregate (angular gravel, clear of fines) placed behind walls helps eliminate water accumulation. Because no mortar is used in VERSA-LOK wall construction, water is free to

weep through joints of installed units. For walls greater than three feet in height, a perforated drain pipe is recommended at the base of the drainage aggregate to quickly remove large amounts of water.

If high groundwater levels are anticipated or if the wall is along a shoreline, additional drainage materials behind and below reinforced fill may be required. Filter fabric may be required to prevent unwanted migration of fine soil particles into the drainage aggregate.

Surface Drainage

Wall sites should be graded to avoid water flows, concentrations, or pools behind retaining walls. If swales are designed at the top of walls, properly line and slope them so water is removed before it can flow down behind walls.

Give special attention to sources of stormwater from building roofs, gutter downspouts, paved areas draining to one point, or valleys in topography. Be sure to guide flows from these areas away from retaining walls. Slope the soil slightly down and away from wall bases to eliminate water running along bases and eroding soil. If finish grading, landscaping, or paving is not completed immediately after wall installation, temporarily protect the wall from water runoff until adjacent construction and drainage control structures are completed.

Properly compacted soils and drainage controls are critical components of Mosaic walls.

VERSA-LOK® Mosaic® Wall Components

Geosynthetics such as VERSA-Grid® reinforce backfill soils, allowing construction of stable Mosaic walls exceeding 40 feet in height.

Geosynthetic Reinforcement

Geosynthetics are durable, high-strength polymer products designed for use as soil reinforcement. Horizontal layers of geosynthetic such as VERSA-Grid® provide tensile strength to hold the reinforced soil together, so it behaves as one coherent mass. The geosynthetic reinforced soil mass becomes the retaining wall. Sufficient length and strength of geosynthetic can create a reinforced soil mass large enough and strong enough to resist destabilizing loads. Geosynthetic layers also connect the VERSA-LOK units to the reinforced soil.

Geosynthetics are made from several types of polymers that resist installation damage and long-term degradation. Geosynthetics are designed to interact with the soil for anchorage against pullout and resistance to sliding.

Geogrids, the most common soil reinforcement for walls, are formed with an open, grid-like configuration. Geotextiles (solid fabrics) are also used. Product specific testing determines the durability, soil interaction, and strength of each type of geosynthetic. The interaction of various geosynthetics with VERSA-LOK units (*connection strength*) is also tested.

Geosynthetic layers must be nominally tensioned and free of wrinkles when placed. Geosynthetics are generally stronger in one direction, the roll direction. It is important that the high-strength direction be placed perpendicular to the wall face, in one continuous sheet (no splices). Along the wall length and parallel to the face, adjacent sections of reinforcement are placed immediately next to each other without overlap to create 100 percent coverage with no gapping, and with special details for curves and corners.

The needed type, length, vertical spacing, and strength of geosynthetic vary with each project depending on wall height, loading, slopes, and soil conditions. A professional Civil Engineer (P.E.) must prepare a final, geogrid-reinforced wall design for each project.

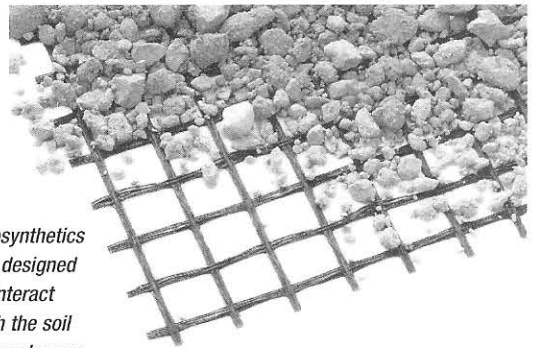

Geosynthetics are designed to interact with the soil for anchorage.

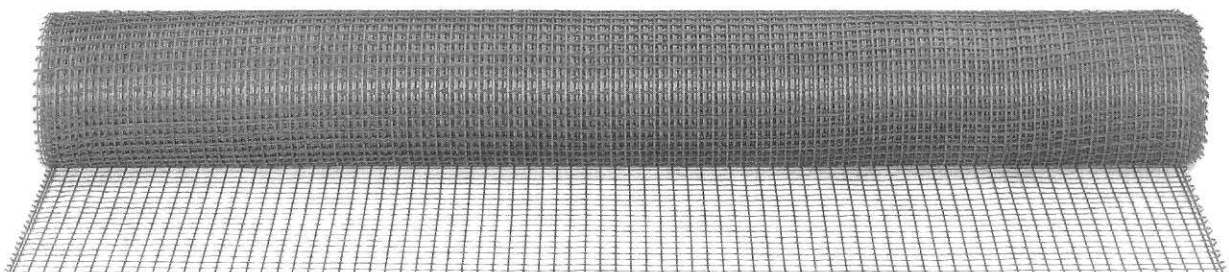

Geosynthetics provide tensile strength to backfilled soils.

Special Design Considerations

Shorelines

VERSA-LOK® segmental retaining walls perform well in shoreline applications. However, special design considerations are often necessary to ensure that water pressures do not build up behind walls. Special provisions may include granular reinforced backfill, additional drainage aggregate, drainage behind reinforced soil masses, and filter fabric. Protection of bases from water scour, wave action, and ice may also be necessary.

See VERSA-LOK Technical Bulletin #1 for more information regarding shorelines and retention pond protection.

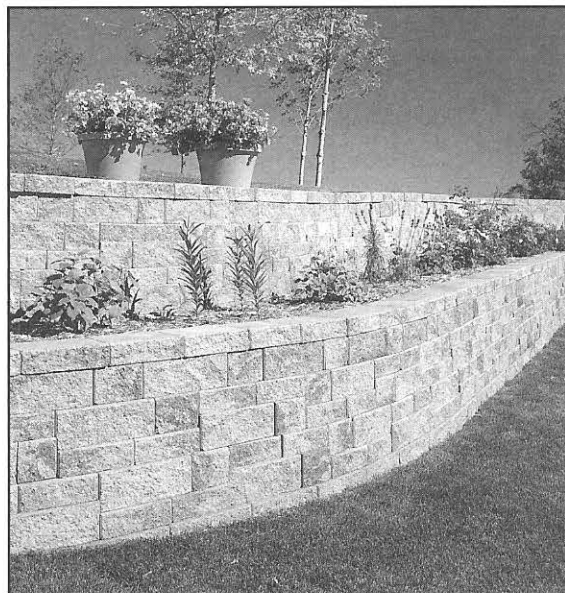

With proper design, Mosaic walls can accommodate special site conditions such as water loads, slopes or surcharges.

Loads Behind Walls

Surcharge loads and slopes behind walls can substantially increase amounts of required soil reinforcement. Common surcharge loads include parking areas, driveways, and building structures. For design purposes, permanent loads like buildings and slopes are considered to contribute to both destabilizing and stabilizing forces acting on walls. Dynamic forces like vehicular traffic are considered to contribute to destabilizing forces only. Often, the highest surcharge loads are caused by grading or paving equipment during construction. Heavy equipment should be kept at least three feet behind the back of retaining wall units. Soil reinforcement designs should accommodate all anticipated surcharge loads—even if they will occur infrequently or just once.

Tiering

Aesthetically, it may sometimes be desirable to divide large grade changes into tiered wall sections. However, upper wall tiers can add surcharge loads to lower walls and necessitate special designs. To avoid loading lower walls, upper walls must be set back horizontally at least twice the height of the lower walls. If walls are placed closer, lower walls must be designed to resist the load of upper walls.

Several closely spaced tiered walls can create steep, unstable slopes. If tiered walls make a grade change steeper than 2:1 (horizontal: vertical), global slope stability may need to be reviewed by a qualified soils engineer. See VERSA-LOK Technical Bulletin #7 for more information regarding tiered wall construction.

Planning, Estimating & Final Designs

VERSA-LOK's technical staff is available to assist in planning, layout, estimating, and referrals for final engineering.

Planning

Careful planning is critical to successful projects. Prior to design, accurate information needs to be gathered including soil conditions, proposed wall heights, topography, groundwater levels, and surface water conditions. Proper permits, owner approvals, utility clearances, and temporary easements should also be obtained in advance.

Planned wall alignments should be reviewed for feasibility. Make sure that layouts account for minimum curve radii, wall setback, and area needed for geosynthetic soil reinforcement. Be sure that all wall components fit within property constraints. Verify that temporary construction excavations will not undermine foundation supports of any existing structures or utilities. Considerations should also be given to site access for equipment and materials.

Estimating

Accurately estimate and order required materials including VERSA-LOK® units, VERSA-TUFF® Snap-Off Pins, cap units, VERSA-LOK Concrete Adhesive, imported backfill, leveling pad materials, VERSA-Grid® geosynthetic soil reinforcement, drainage aggregate, and additional drainage materials. The Mosaic® Unit Estimation Chart on page 12 shows how to determine quantities of the various Mosaic units. See the Material Estimation Worksheet on page 29 to help determine quantities of all VERSA-LOK products.

For reinforced-wall projects, the VERSA-Grid estimation charts on page 30 provide approximate amounts of geogrid soil reinforcement necessary to construct walls in various soil and loading conditions. For tall walls or complex situations, VERSA-LOK staff engineers can prepare project-specific preliminary designs for geogrid estimation purposes.

Planning, Estimating & Final Designs

Mosaic® Unit Estimation Chart

Each Mosaic panel is 1.66 square feet in wall-face area. For each panel, there is one Standard unit, two Accent® units, and one Cobble® unit. The following formulas and table may be used to estimate quantities of units required for a Mosaic retaining wall project.

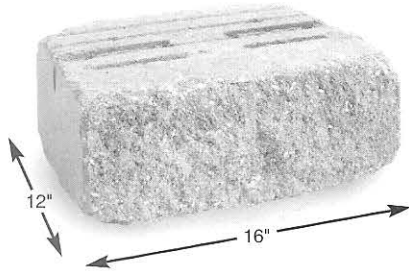

No. of **STANDARD UNITS** =
Wall Square Footage ÷ 1.66

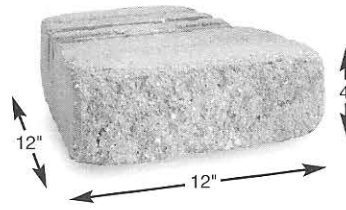

No. of **ACCENT UNITS** =
Wall Square Footage ÷ 1.66 x 2

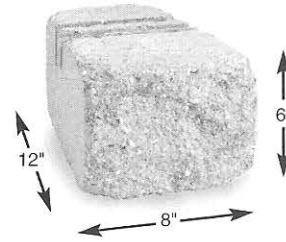

No. of **COBBLE UNITS** =
Wall Square Footage ÷ 1.66

EACH PANEL REQUIRES 8 PINS

VERSA-LOK MOSAIC QUANTITY ESTIMATION CHART*

Exposed Wall Height	Exposed Wall Length	10 feet	12 feet	14 feet	16 feet	18 feet	20 feet	22 feet	24 feet	26 feet	28 feet	30 feet
10 inches	Standard	5	6	7	8	9	10	11	12	13	14	15
	Cobble	5	6	7	8	9	10	11	12	13	14	15
	Accent	10	12	14	16	18	20	22	24	26	28	30
20 inches	Standard	10	12	14	16	18	20	22	24	26	28	30
	Cobble	10	12	14	16	18	20	22	24	26	28	30
	Accent	20	24	28	32	36	40	44	48	52	56	60
30 inches	Standard	15	18	21	24	27	30	33	36	39	42	45
	Cobble	15	18	21	24	27	30	33	36	39	42	45
	Accent	30	36	42	48	54	60	66	72	78	84	90
40 inches	Standard	20	24	28	32	36	40	44	48	52	56	60
	Cobble	20	24	28	32	36	40	44	48	52	56	60
	Accent	40	48	56	64	72	80	88	96	104	112	120

*This chart does not include estimates for embedded (buried) units. The quantity of embedded units (generally all Standard units) should also be added to these quantities.

For walls over four feet high, a licensed professional civil engineer (P.E.) should prepare the final wall design.

Final Designs

Final wall designs may be provided prior to putting projects out for bidding. Alternatively, wall portions of projects can be specified design/build. With design/build projects, engineers/architects provide wall layout information (line and grade) but not final engineering for the wall. Contractors submit bids based on this layout including estimated labor, materials, and final engineering costs. Contractors who are awarded projects retain licensed engineers to prepare final wall designs and submit shop drawings for approval from project engineers/architects.

As with all proposed construction, a soils report prepared by a qualified geotechnical engineer is required to provide adequate information for proper design. The soils report should address overall stability of planned grade changes and allowable bearing capacity of foundation soils. The report should also include information about reinforced and retained soil properties.

For assistance in specifying, designing, and engineering VERSA-LOK® walls, sample wall specifications are provided on pages 32 to 38 and sample construction details are provided on pages 39 to 42. Additional details and specifications are available in electronic format: Call (800) 770-4525 for more information or visit our website at www.versa-lok.com. VERSA-LOK's technical staff is also available to assist with planning, layout, preliminary engineering, and referrals for final engineering.

For walls more than four feet in height, most building codes require a final wall design prepared by a licensed Civil Engineer (P. E.) registered in that state. VERSA-LOK and its manufacturers have a network of licensed Civil Engineers who are familiar with segmental retaining wall design. These individuals are available for referrals to architects, engineers, or contractors with final wall design needs.

Mosaic® Wall Construction

Tools

The following tools may be helpful during construction of Mosaic® segmental retaining walls:

VERSA-Lifter®

Block Splitter

Safety Protection

Vibratory Plate Compactor

Diamond-Blade Concrete Saw

Caulking Gun

Backhoe or Skid-Steer Loader

Four-Foot Level

String Line

Hand Tamper

Transit or Site Level

Finishing Trowel

Tape Measure

Four-Pound Sledge Hammer

Broom

Brick Hammer

Shovel

Three-Inch Masonry Chisel



The VERSA-Lifter helps installers construct VERSA-LOK® Standard retaining walls by making it easier to lift and place units — especially on the base course. Two prongs on the Lifter are inserted into pin holes in each VERSA-LOK Standard unit. Lifting the handle secures the Lifter to the unit and makes for easy, balanced lifting and placement.

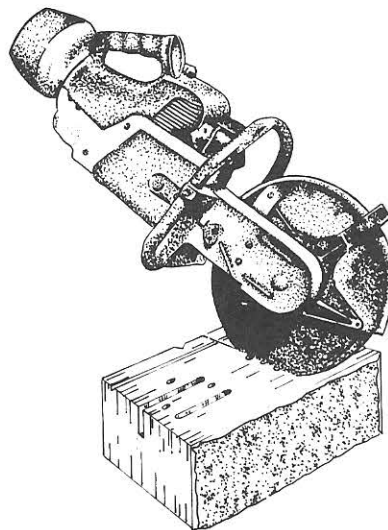

Mosaic® Wall Construction

VERSA-LOK Mosaic units are easily modified by splitting for a textured face, or by saw-cutting for a smooth side.

Unit Modification

During wall construction, it may be necessary to split or cut VERSA-LOK® Mosaic® units. Splitting creates an attractive textured face on any visible sides of a Mosaic unit that matches the split-face on the front of the unit. Saw-cutting creates a smooth straight edge on a partial unit, so it can fit tightly next to adjacent units. Remember to always wear proper safety protection when performing splitting or cutting operations.

To split units with a masonry chisel and hammer, mark a path on the unit's top, bottom, and back. Score along the top and bottom paths using the chisel and a heavy hammer. Place the unit on its face and strike along the back path. It is easier to split units on the ground than on a hard surface. The unit should fracture nicely along the paths. If many splits will be required for a project, it may be helpful to rent a mechanical or hydraulic block splitter from your block supplier or rental center.

Saw-cuts are normally made using a gas-powered cut-off saw with a diamond blade. Before you saw-cut a unit, mark a line on each side to be cut. Place the unit face toward you with the top side up, at a comfortable height on a stable work surface. Make a straight cut down and two to three inches into the face. Move saw to top of unit, and cut through top using successively deeper cuts. Flip unit over and finish by cutting completely through the bottom of the unit.

Excavation

Excavate just deeply enough to accommodate the leveling pad (which is normally 6 inches thick) and the required unit embedment below grade. When necessary, also excavate areas where geosynthetic soil reinforcement will be placed. Required unit embedment varies with wall height and site conditions. Generally, if grade in front of the wall is level, one-tenth of the exposed wall height should be buried below grade.

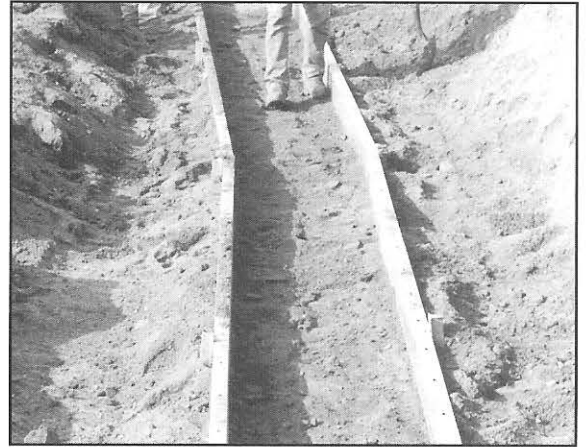

Additional embedment may be required for special conditions including slopes in front of walls, soft foundation soils, and shoreline applications. Compact soil at the bottom of excavation—do not place Mosaic units on loose, soft, wet, or frozen soil—settlement may result. If the wall will set on previously backfilled excavations, such as utility line trenches, be sure the entire depth of existing backfill is well compacted. If necessary, over-excavate soft soils and replace with properly compacted backfill.

Mosaic® Wall Construction

Leveling Pad

Place granular leveling pad material and compact to a smooth, level surface. Leveling pad should be at least six inches thick and 24 inches wide. It should consist of crushed stone. The most commonly used material for leveling pads is what is used locally as road base aggregate. To construct long sections of leveling pad, create forms by leveling and staking rectangular metal tubing along both sides of the planned pad. Place and compact granular material within these leveled forms and screed off excess.

Always begin at the lowest level and work upward in situations where the planned grade along the wall front changes elevation. Use a thin layer of fine sand on top of the leveling pad for final leveling.

See *VERSA-LOK® Technical Bulletin #5* for more tips on leveling pad construction.

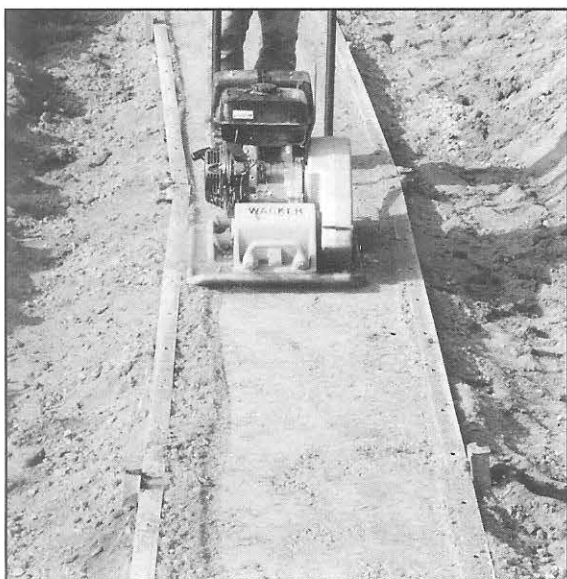

Base Course

Make sure that the leveling pad is level and begin placing base course units. For ease of installation, use only VERSA-LOK Standard units for the base course. This will create a uniform “platform” on which to build the Mosaic® panels.

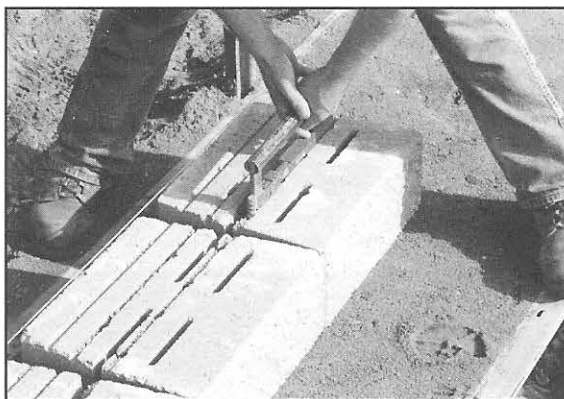

Align base units using their backs or slots, rather than their irregularly textured front faces. String lines may also be helpful when aligning straight walls. Place units side by side on the leveling pad. Fronts of adjacent units should fit tightly and unit bottoms should contact the leveling pad completely. Using a four-foot level, level all units front to back, side to side, and with adjacent units. Take time to ensure a level base course—minor unevenness in the base course will be amplified and difficult to correct after several courses of panels have been installed. After the base course has been positioned, place and compact soil backfill behind units. Also replace and compact over-excavated soil in front of the units. Backfill placed behind and in front of embedded units should consist of soil, not drainage aggregate.

Take time to ensure a level base course—minor unevenness in the base course will be amplified and difficult to correct after several courses of panels have been installed.

Mosaic® Wall Construction

Always install an entire ten-inch-high, four-unit panel before proceeding to the next panel on that course.

Installing First Course of Panels

To start the first course of panels, place two Accent® units next to each other on top of the base course units. Set the units back 3/4 inch. Insert two VERSA-TUFF® Snap-Off Pins through two of the four front holes in the Accent units so they fall into the middle slots of the VERSA-LOK® Standard base units below. Snap-off the top exposed portion of the pins. Finish this ten-inch-high, 24-inch-wide panel by placing a Standard unit and a Cobble® unit on top of the Accent units with a setback of 3/4 inch.



*Mosaic® walls are built one panel at a time!
Always install an entire ten-inch-high, four-unit panel before proceeding to the next panel on that course.*

Insert two VERSA-TUFF Snap-Off Pins through the front holes of each Standard and Cobble unit so they fall into the front slots of the Accent units below. After pinning, pull the units forward to remove any looseness in the pin connections. Check alignment at the back of the units.

Adjacent to this completed panel, start the next panel by placing a Standard unit and a Cobble unit on the base course and two Accent units on top of those, pinning each unit accordingly.

Alternate placing the two Accent units with the Standard/Cobble units on the bottom. Randomly mix the order of Cobble and Standard units within the panels to avoid a repetitive pattern. Continue constructing panels throughout the length of the wall. Do not proceed to the next course of panels until you have completed the entire previous course, including all pinning.

Check levelness at the top of each panel, and panel to panel. Remember to sweep off the tops of installed panels to remove any debris that may interfere with laying additional courses.

Mosaic® Wall Construction

Pinning Mosaic® Panels

Two VERSA-TUFF® Snap-Off Pins are normally used for each unit in a Mosaic panel, making a total of eight VERSA-TUFF Pins per panel. Because of the variable bond and offset placement of panels that occurs in the Mosaic pattern, sometimes only one VERSA-TUFF Pin will fit into a lower unit—resulting in less than eight VERSA-TUFF Pins per panel.

Make sure VERSA-TUFF Pins are fully seated in slots of lower units. If necessary, seat VERSA-TUFF Pins using a mallet and another VERSA-TUFF Pin. For six-inch-high Standard and Cobble® units, VERSA-TUFF Pins are fully seated when they are recessed below the top surface of units. For Accent® units, the top two inches of the pin will initially stick out of the unit. Snap off this exposed section of the VERSA-TUFF Pin by hitting the top of the pin from the side.

Always pin to the front slots in the Accent and Cobble units and to rear slots in the VERSA-LOK® Standard unit. Each Mosaic unit sets back 3/4 inch from the unit below, regardless of its height. Because the completed Mosaic panel is two units high, there is a combined 1.5 inch total setback per ten-inch-high panel, resulting in an approximate 8.5 degree batter (cant) from vertical.

VERSA-LOK's unique hole-to-slot pinning system allows for easy top-down pinning and variation in the bond of the panels.

Each Mosaic panel should be staggered from panels below.

Installing Additional Courses of Panels

When there is no fixed starting point, start the next ten-inch-high course by staggering the panels at least four inches from the vertical joints between the panels below. Patterns in the Mosaic® panels should not line up with the course below it. Vary this bond on subsequent courses of panels to create a random look. Pin units within each panel and to the panels below as described previously. When laying additional courses of panels that start at a corner, wall panel locations will be dictated by the corner panels.

Pull units forward to remove any looseness in the pin connections. Check the alignment at the top of each course of panels and adjust as needed. Stack no more than two courses of panels (20 inches high) before backfilling. If too many panels are placed without backfilling, the panels will be unstable and may push out of alignment during backfilling. If course panels must fit into a limited horizontal space, adjust by placing a partial panel (less than 24 inches wide). Saw cut both top and bottom units on one side of the panel to create a panel with the needed width.

Drainage Aggregate

Drainage aggregate placed behind segmental retaining walls helps eliminate water accumulation and hydrostatic pressure behind walls. Beginning at the level of planned grade in front of the wall, place drainage aggregate between and directly behind units to a minimum thickness of 12 inches. Drainage aggregate should consist of 3/4-inch clear, free-draining, angular gravel that is free of fine dirt and soil.



Do not place drainage aggregate behind units that will be embedded. For walls higher than three feet, a perforated drain pipe should be used to collect water along the base of the drainage aggregate. For some projects, such as shoreline applications, geosynthetic fabric may be required behind the drainage aggregate to prevent soils or sands from migrating into the drainage aggregate and wall face joints.

Mosaic® Wall Construction

Compacted Soil Backfill

Proper compaction of foundation and backfill soil is critical to long-term performance of retaining wall systems. Coarse soils usually require less soil reinforcement and are easier to compact than fine soils.



Place soil backfill beginning directly behind drainage fill in layers no thicker than six inches. Compact soil backfill, making sure that the backfill is neither too wet nor too dry. The amount and type of effort needed for adequate backfill compaction varies with soil type and moisture content. Generally, hand-operated vibratory plate compactors can be used to achieve adequate compaction of granular soils.

To avoid pushing wall units out of alignment, heavy self-propelled compaction equipment should be kept at least three feet behind back of retaining wall units.

Geosynthetic Soil Reinforcement

Geosynthetic soil reinforcement such as VERSA-Grid® is used to reinforce soil backfill when the weight of VERSA-LOK® units alone is not enough to resist soil pressures. Soil reinforcement type, length, and vertical spacing will vary for each project and should be specified by a qualified engineer. For the Mosaic® system, the minimum vertical spacing possible between layers of geogrid is the height of the panels, ten inches. This ten-inch increment for grid spacing should be accounted for in the final engineering design.

Prepare to install soil reinforcement materials by placing Mosaic panels and backfilling up to the height of the first soil reinforcement layer specified on construction drawings. The top of each ten-inch high course of panels creates a flat surface for level geogrid placement. Lay soil reinforcement horizontally on top of compacted backfill and Mosaic panels. Geosynthetics are usually stronger in one direction. It is very important to place them in the correct direction. The strongest direction of the geosynthetic must be perpendicular to the wall face. For correct orientation, follow the geosynthetic manufacturer's directions carefully. After positioning soil reinforcement, place the next course of Mosaic® panels on top of the soil reinforcement.

The strongest direction of the geosynthetic (almost always the roll direction) must be perpendicular to the wall face.

Mosaic® Wall Construction

Keep geosynthetic taut and remove any slack by pulling it away from the wall face.

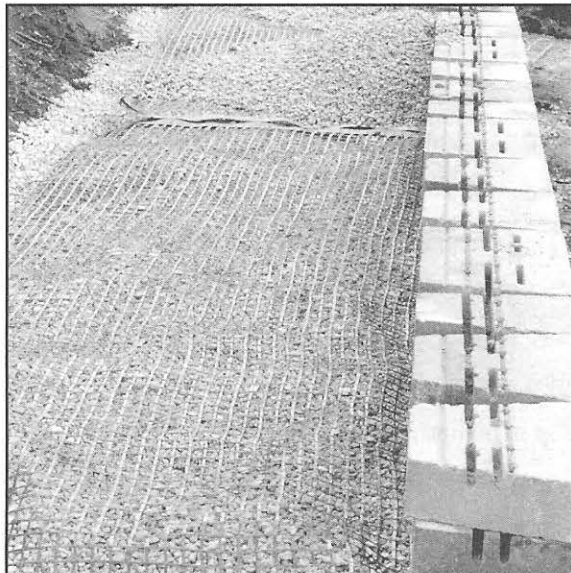

Insert pins through the bottom panel units, through the geosynthetic, and into the slots of the panel below. Place drainage aggregate against the back of the units and on top of the soil reinforcement. Remove slack by pulling soil reinforcement away from the wall face and anchoring at back ends. Beginning at the drainage aggregate, place and compact soil backfill. Keep soil reinforcement taut and avoid wrinkles. Place a minimum of ten inches of soil backfill before using any tracked equipment on top of soil reinforcement. Placing soil reinforcement behind curves and corners requires special layout and overlapping procedures. Never overlap soil reinforcement layers directly on top of each other—always provide at least three inches of soil fill between overlapping soil reinforcement layers.

See VERSA-LOK® Technical Bulletin #3 for more curve/corner soil reinforcement details.

Caps

Finish Mosaic retaining walls by placing standard VERSA-LOK cap units along the top of the wall. Two cap units are available—Type A and Type B. Alternate A and B caps on straight walls. Use A caps for convex (outside) curves. Use B caps for concave (inside) curves. Front faces of caps may be placed flush, set back, or slightly extended over faces of VERSA-LOK Mosaic units. Caps are secured with two continuous, 1/4-inch beads of VERSA-LOK Concrete Adhesive placed along the top course of wall units. Set and press the caps onto these prepared wall units.

See VERSA-LOK® Technical Bulletin #4 for more about capping.

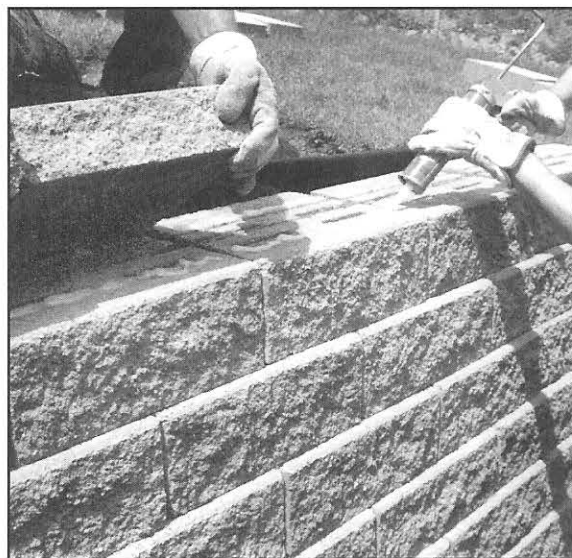

Basic Wall Design Elements

Curves

Curves in a Mosaic® wall are created by fanning apart or bringing together the backs of units. The trapezoidal shape of Mosaic units permits a wide range in radii of convex, concave, and serpentine curves. However, convex (outside) curves in Mosaic walls cannot be built tighter than an eight-foot radius. Also, concave (inside) curves built with less than a six-foot radius look ragged in appearance. An inside corner is recommended in place of a tight inside curve.

When constructing curves, install each ten-inch-high panel completely before proceeding to the adjacent panel. Generally, keep the vertical joints at the front of units tight-fitting. There will, however, be some minor gapping between units in curved Mosaic walls to account for changes in curve radii as courses set back.

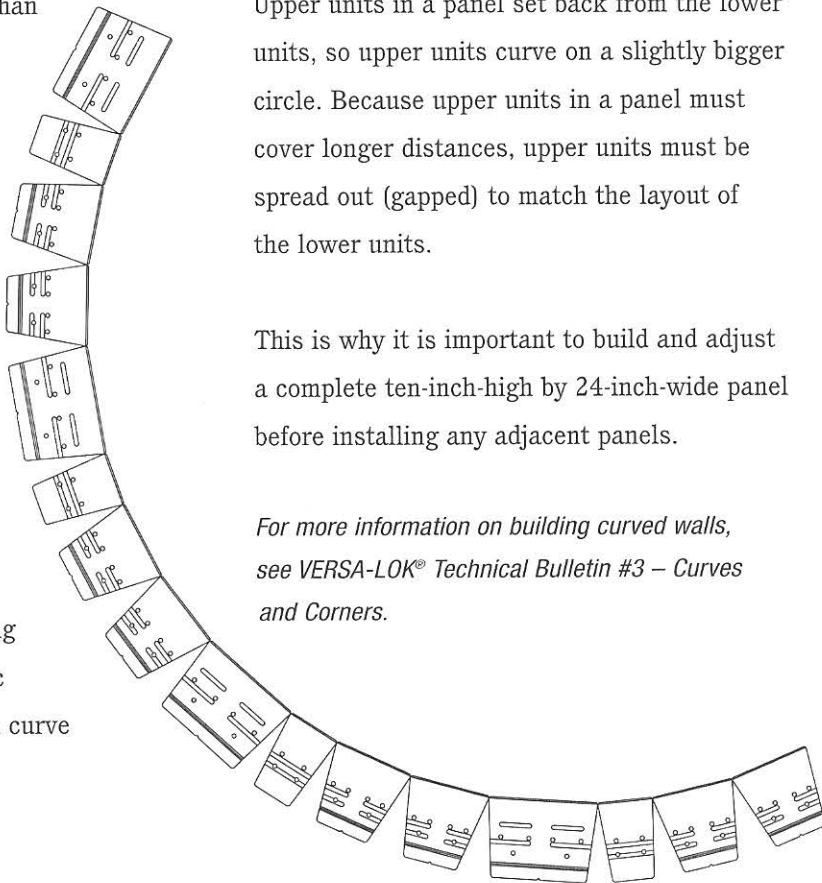

Concave (Inside) Curves

Construct concave curves by increasing spaces between the backs of units. For a smooth curve, concave curves should have a minimum six-foot radius at the bottom of the wall.

Some slight gapping is needed between upper units of panels to adjust to changing radii.

Upper units in a panel set back from the lower units, so upper units curve on a slightly bigger circle. Because upper units in a panel must cover longer distances, upper units must be spread out (gapped) to match the layout of the lower units.

This is why it is important to build and adjust a complete ten-inch-high by 24-inch-wide panel before installing any adjacent panels.

For more information on building curved walls, see VERSA-LOK® Technical Bulletin #3 – Curves and Corners.

Minor gapping between some units is necessary to account for changes in the curve radius as each course sets back.

Basic Wall Design Elements

Convex (Outside) Curves

Create convex curves by decreasing the space between the backs of the units. The minimum outside radius for a Mosaic® wall is eight feet at the top of the wall.

To properly install Mosaic curves, build and adjust a complete panel before installing adjacent panels.

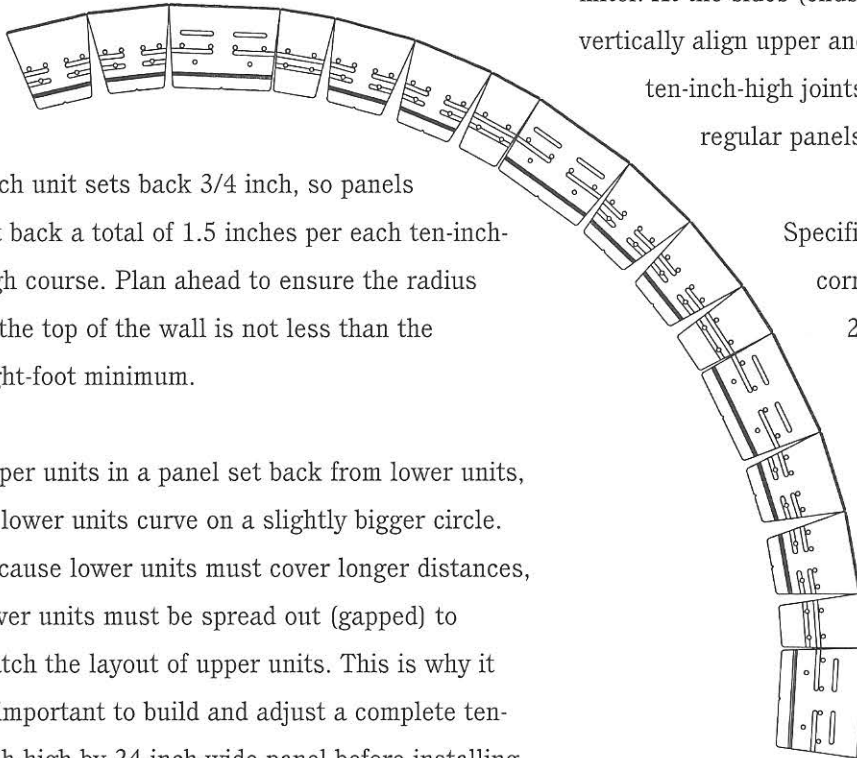

Each unit sets back $\frac{3}{4}$ inch, so panels set back a total of 1.5 inches per each ten-inch-high course. Plan ahead to ensure the radius at the top of the wall is not less than the eight-foot minimum.

Upper units in a panel set back from lower units, so lower units curve on a slightly bigger circle. Because lower units must cover longer distances, lower units must be spread out (gapped) to match the layout of upper units. This is why it is important to build and adjust a complete ten-inch-high by 24-inch-wide panel before installing any adjacent panels.

Corners

Solid Mosaic units are easily modified to create a variety of angled corners. Always build ten-inch-high corner panels first, then work out from the corner. Overlap and interlock corners—do not miter. At the sides (ends) of corner panels, vertically align upper and lower units to create ten-inch-high joints to butt against adjacent regular panels.

Specific examples of 90-degree corners are shown on pages 24-26. Various angled corners such as 45-degree corners can be built by similar methods.

For information on specialty corners, contact the VERSA-LOK® technical staff.

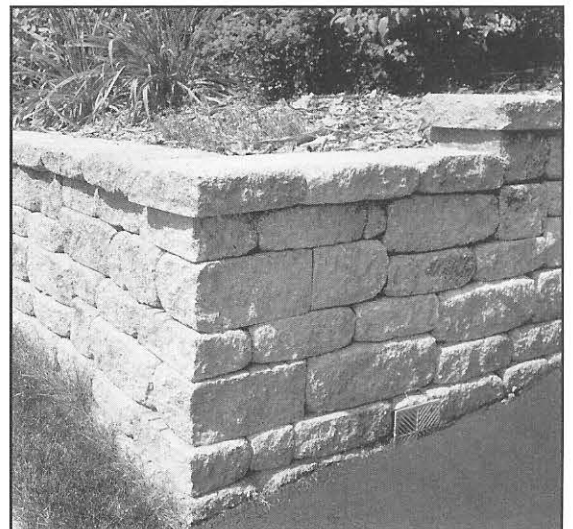

Basic Wall Design Elements

Outside 90° Corner

For the first ten-inch high corner panel, split a Standard unit and an Accent® unit into halves. Next, cut off the backs of two of the split half units as shown (Figure A and B). Also cut or split off the rear corner of a whole Standard unit (Figure A). For the lower portion of the corner panel, place the modified half-Standard unit at the corner. Place the corner-cut Standard unit and a Cobble® unit at its sides (Figure A).

For the upper portion, place the modified half-Accent unit at the corner, with whole Accent units at both sides (Figure B). Complete this ten-inch-high course by building out from the corner panel with Mosaic® panels. On the next course, install another ten-inch-high corner panel that is basically the mirror image of the first course corner panel (Figures C & D). For the remaining courses, repeat these corner panels until reaching desired wall height.

For each course, always build a ten-inch high corner panel first, then work out from this corner panel.

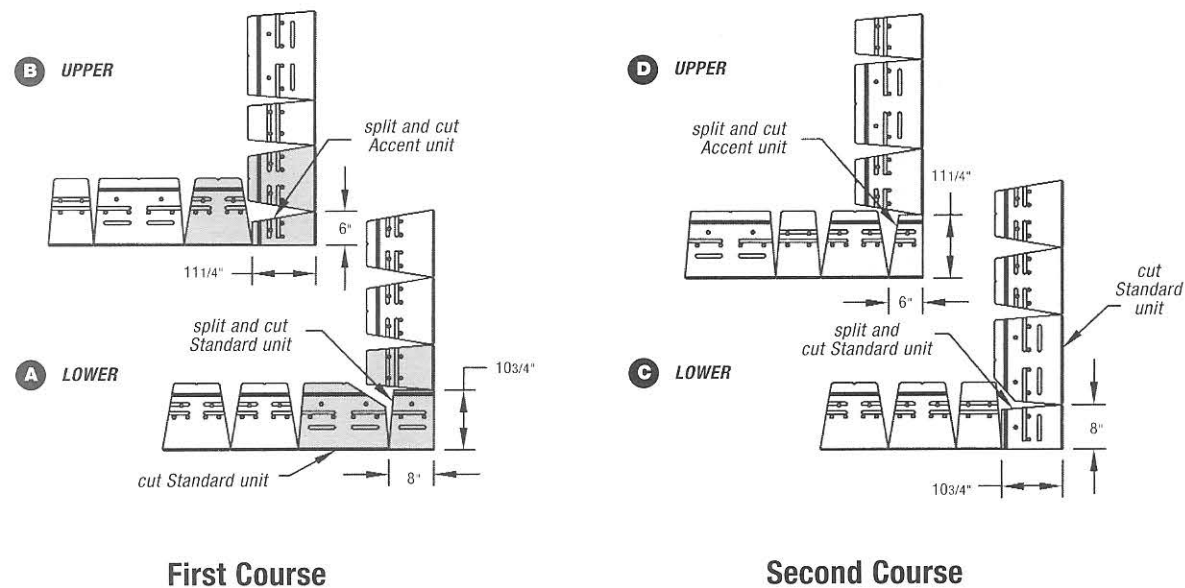
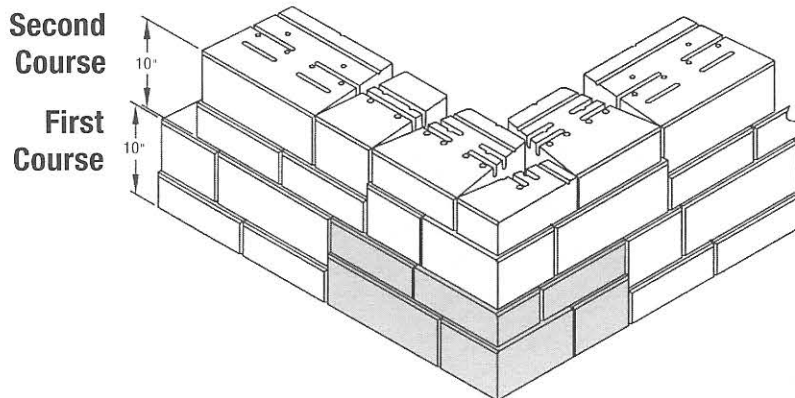

Basic Wall Design Elements

Outside 90° Corner at Stairs

When building an outside corner at stairs, the side wall abutting the stairs should be vertical (see page 29). For the first ten-inch-high corner panel, split a Standard and an Accent® unit into halves and cut off the back of the Standard half unit as shown (Figure A). Also cut or split off the rear corner of a whole Standard unit (Figure A). Place the half-Standard unit at

the corner, with a corner-cut Standard unit and a Cobble® unit at its side (Figure A). Above this, place the half-Accent unit at the corner, with whole Accent units at both sides (Figure B). On the next course, install another ten-inch-high corner panel similar to the first course panel (Figures C & D). For the remaining courses, repeat these corner panels until reaching desired wall height.

For corners at stairs, the front wall sets back but the side wall is vertical.

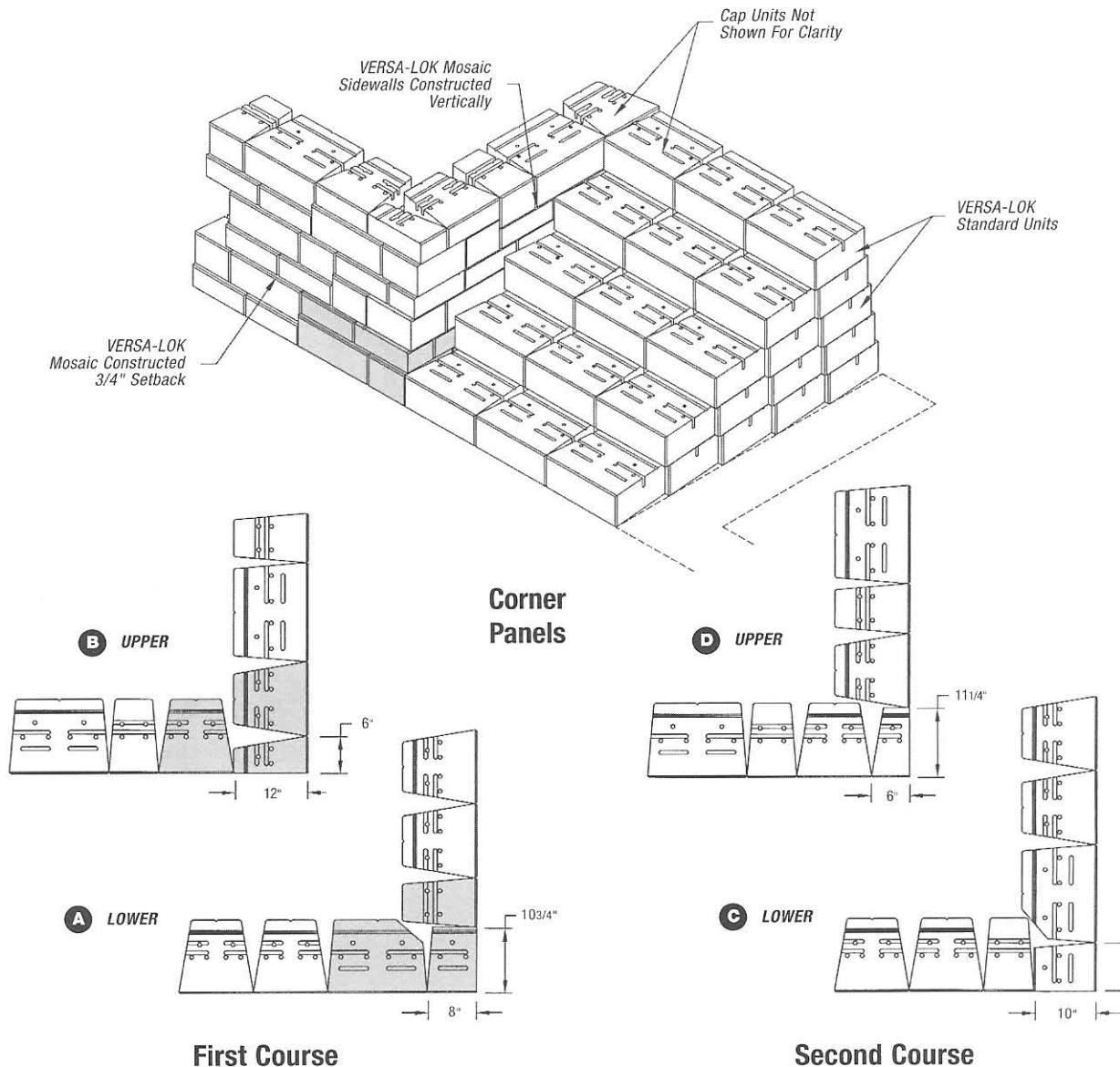

Basic Wall Design Elements

Inside 90° Corners

For the first ten-inch-high course of a 90-degree inside corner, butt the left side panel into the right side panel (Figures A & B). This hides part of the right side panel that runs “wild” past the corner. Upper and lower portions of both panels meeting at the corner should have units of the same height. In the illustrations below, lower units of the first-course corner panels are all four inches high. Modify the left side panel

to fit snugly against the setback in the right side panel face by saw cutting 3/4 inch off the lower unit (Figure A). Build regular Mosaic® panels out from the corner panels to complete the first course. On the second course, butt the right side panel into the left side panel and saw cut the lower right side unit (Figures C & D). For remaining courses, repeat these corner panels until reaching desired wall height.

For inside corners, saw-cut units in the abutting panels to fit snugly against the setback within the adjacent panels.

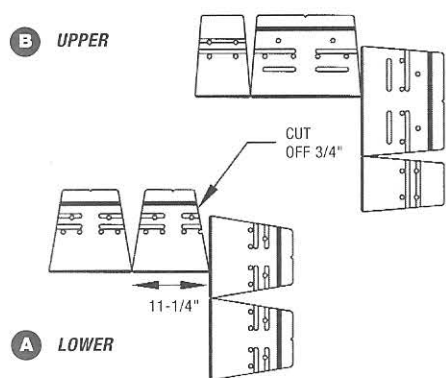
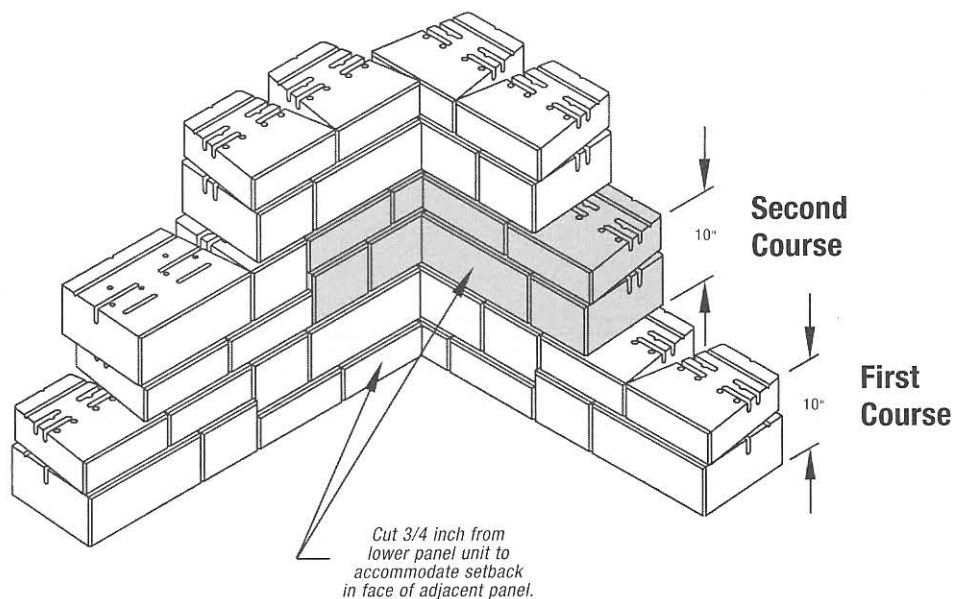

First Course

Corner Panels

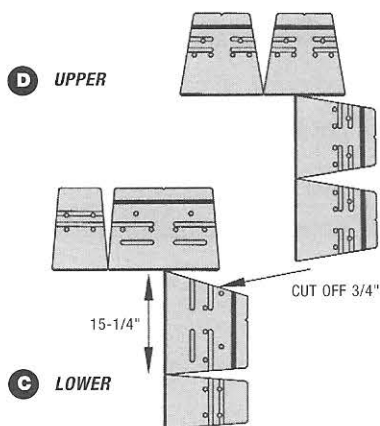

Second Course

Basic Wall Design Elements

Create attractive step-downs by splitting sides of caps and Standard units.

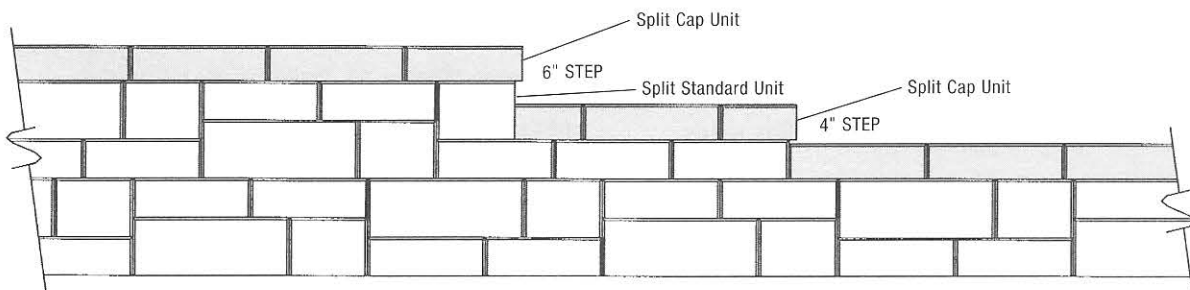

Stepping Top of Wall

Wall tops should step to match grade changes. If a Mosaic® wall steps down six inches, use a modified Standard unit at the transition. Split a Standard unit in half so the textured wall end will match the wall face. When a step is four inches, splitting the Accent® unit is not necessary. The sides of two cap units should also be split to maintain texture on wall ends.

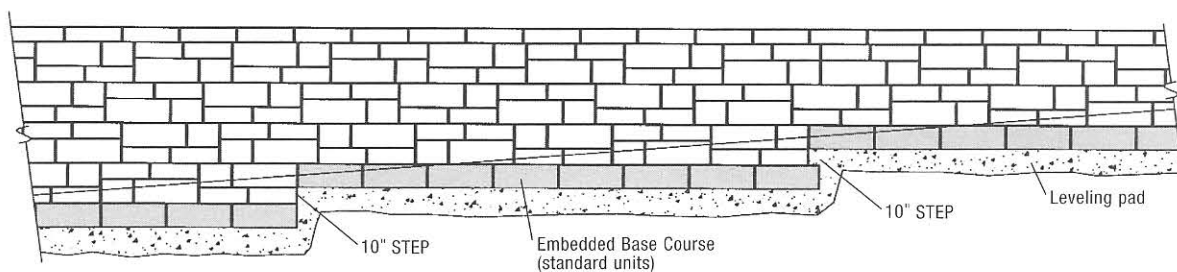

Stepping Base of Wall

If the planned grade along the front of a Mosaic wall changes elevation, the leveling pad should be stepped in ten-inch increments to match the grade change. Always start wall construction at its lowest level and work upward. Step the leveling pad only often enough to avoid burying extra units while maintaining required minimum unit embedment. With the Mosaic pattern, always build with full ten-inch-high panels after base course installation.

Some of the base course of VERSA-LOK® Standard units can show above grade without changing the random look of the wall face pattern.

Advanced Wall Features

Stairs

Stairs with a ratio 2:1 (horizontal: vertical) can be easily installed using VERSA-LOK® Standard units and caps as stair risers and treads.

Mosaic® units are used for the outside 90-degree corners and the side (return) walls next to the steps. As in most VERSA-LOK step installations, side walls will be vertical (not set back) so that both riser and tread units fit securely in the opening. Since VERSA-LOK steps are six-inches-high and the side walls are built in ten-inch-high courses, a difference in height between the side walls and top step may occur.

In most Mosaic step installations, the area exposed at the side walls will be minimal. Therefore, it is generally not necessary to use the typical Mosaic panel configuration in this area. Alternating six-inch-high Standard and Cobble® units with four-inch-high Accent® courses is an easier approach to stairway side wall installation.

See VERSA-LOK Technical Bulletin #2, VERSA-LOK Stairs, for more information.

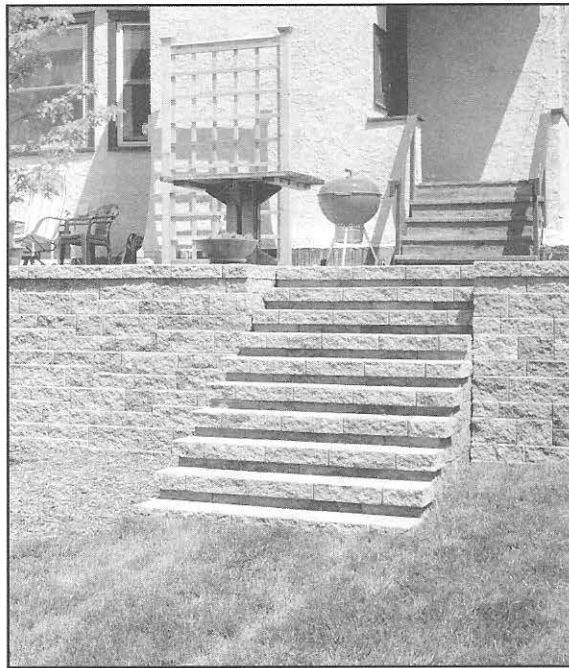

With proper planning, Mosaic walls can nicely incorporate stairs made from VERSA-LOK Standard units and caps.



Fences/Railings

VERSA-LOK walls can be topped with a variety of barriers, including fences, railings, and guide rails.

See VERSA-LOK Technical Bulletin #8, Fences, Railings, & Traffic Barriers, for more information.

Mosaic® Material Estimation Worksheet

VERSA-LOK® Standard Units

Area of Wall (SF) ÷ 1.66 = Number of Standard Units

_____ SF ÷ 1.66 = _____ Units Needed*

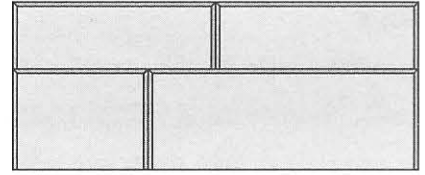

1.66 Sq. Ft.

VERSA-LOK® Accent® Units

Area of Wall (SF) ÷ 1.66 x 2 = Number of Accent Units

_____ SF ÷ 1.66 x 2 = _____ Units Needed

VERSA-LOK® Cobble® Units

Area of Wall (SF) ÷ 1.66 = Number of Cobble Units

_____ SF ÷ 1.66 = _____ Units Needed

VERSA-TUFF® Snap-Off Pins

Area of wall (SF) ÷ 1.66 x 8 = Number of Pins

_____ SF ÷ 1.66 x 8 = _____ Pins Needed

(Base course of VERSA-LOK Standard Units does not require pins.)

VERSA-LOK® Caps

Lineal Feet of Wall (LF) x .86 = Number of Caps

_____ LF x .86 = _____ Caps Needed

straight walls - use half **A** caps and half **B** caps

inside curves - use **B** caps

outside curves - use **A** caps

Additional caps may be needed for special splits or cuts.

VERSA-LOK® Concrete Adhesive

11 oz. Tube: _____ LF ÷ 14 LF per Tube = _____ Tubes

VERSA-Grid®

For estimating purposes, the tables on the following page provide approximate amounts of VERSA-Grid soil reinforcement needed to construct walls in certain soil and loading conditions. For tall walls or complex situations, VERSA-LOK staff engineers can prepare project specific preliminary designs to be used for estimation purposes.

**This quantity does not include estimates for embedded (buried) units. Estimate the quantity of buried units (generally all Standard units) separately from the exposed wall.*

VERSA-GRID® Estimation Charts

These tables are provided for **estimating purposes only**. They should not be used or relied upon for any application without verification of accuracy, suitability, and applicability for the use contemplated, which is the sole responsibility of the user. A final, project specific design should be prepared by a qualified, licensed, professional Civil Engineer (P.E.) based on actual site conditions. Preparation of these tables did not include consideration or analysis of global slope stability or allowable bearing capacity of foundation soils. These must be reviewed for each project by a qualified Geotechnical Engineer.

There are three tables provided in this guide to help estimate geogrid for different wall loading situations – level backfill, sloping backfill, and surcharges. To estimate geogrid quantities, first look under the **column** appropriate for project soils, determine the height (H) of the proposed wall and read across the **row** (under appropriate soil column) to approximate geogrid type, number of layers, and lengths of each layer.

These design charts assume the following conditions:

- Uniform soil conditions
- Stable foundation soils
- Level grade in front of the wall
- No groundwater/water loads
- Slopes and loads behind the wall as shown
- No additional loading behind wall (such as tiered walls, building loads, etc.)

Design standards and properties used to develop these charts were:

- Design methodology - in general accordance with NCMA Design Manual for SRWs
- Unit weight of soil (γ) 120 pcf
- Internal friction angle of soil (ϕ) as shown on charts
- Long term design strength of the geogrid (LTDS)
- **VERSA-Grid VG 3.0 - 1250 lb/ft**
- **VERSA-Grid VG 5.0 - 1875 lb/ft**

Level Backfill



Gravel ($\phi = 34^\circ$)

H (feet)	D (feet)	L (feet)	layers	VERSA-Grid
4	0.5	0	0	n/a
5	0.5	3.5	2	VG 3.0
6	0.5	4.0	2	VG 3.0
7	1.0	5.0	3	VG 3.0
8	1.0	5.5	4	VG 3.0
9	1.0	6.0	4	VG 3.0
10	1.0	6.5	5	VG 3.0
12	1.0	8.0	6	VG 3.0

Sand ($\phi = 30^\circ$)

H (feet)	D (feet)	L (feet)	layers	VERSA-Grid
4	0.5	4.0	1	VG 3.0
5	0.5	4.0	2	VG 3.0
6	0.5	4.5	2	VG 3.0
7	1.0	5.5	3	VG 3.0
8	1.0	6.0	4	VG 3.0
9	1.0	6.5	5	VG 3.0
10	1.0	7.0	5	VG 3.0
12	1.0	8.5	7	VG 3.0

Clay ($\phi = 28^\circ$)

H (feet)	D (feet)	L (feet)	layers	VERSA-Grid
4	0.5	4.0	1	VG 3.0
5	0.5	4.5	2	VG 3.0
6	0.5	5.0	2	VG 3.0
7	1.0	5.5	3	VG 3.0
8	1.0	6.0	4	VG 3.0
9	1.0	6.5	5	VG 3.0
10	1.0	7.0	6	VG 3.0
12	1.0	8.5	7	VG 3.0

Sloping Backfill

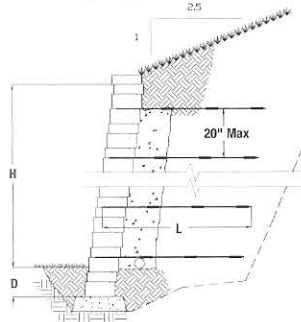

Gravel ($\phi = 34^\circ$)

H (feet)	D (feet)	L (feet)	layers	VERSA-Grid
4	0.5	4.0	1	VG 3.0
5	0.5	4.0	2	VG 3.0
6	0.5	4.5	3	VG 3.0
7	1.0	5.5	4	VG 3.0
8	1.0	6.0	4	VG 3.0
9	1.0	6.5	5	VG 3.0
10	1.0	7.5	6	VG 3.0
12	1.0	8.5	7	VG 3.0

Sand ($\phi = 30^\circ$)

H (feet)	D (feet)	L (feet)	layers	VERSA-Grid
4	0.5	4.5	1	VG 3.0
5	0.5	4.5	2	VG 3.0
6	0.5	5.5	3	VG 3.0
7	1.0	6.5	4	VG 3.0
8	1.0	7.0	5	VG 3.0
9	1.0	8.0	6	VG 3.0
10	1.0	8.5	6	VG 3.0
12	1.0	10.0	7	VG 5.0

Clay ($\phi = 28^\circ$)

H (feet)	D (feet)	L (feet)	layers	VERSA-Grid
4	0.5	4.5	2	VG 3.0
5	0.5	5.5	2	VG 3.0
6	0.5	6.0	3	VG 3.0
7	1.0	8.0	4	VG 3.0
8	1.0	9.5	5	VG 3.0
9	1.0	11.0	6	VG 3.0
10	1.0	12.0	6	VG 5.0
12	1.0	15.0	7	VG 5.0

Surcharge Backfill

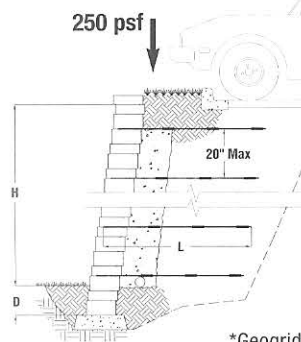

Gravel ($\phi = 34^\circ$)

H (feet)	D (feet)	L (feet)	layers	VERSA-Grid
4	0.5	4.0	2	VG 3.0
5	0.5	4.5	2	VG 3.0
6	0.5	5.0	3	VG 3.0
7	1.0	6.0	4	VG 3.0
8	1.0	6.5	4	VG 3.0
9	1.0	7.0	5	VG 3.0
10	1.0	7.5	5	VG 3.0
12	1.0	9.0	7	VG 3.0

Sand ($\phi = 30^\circ$)

H (feet)	D (feet)	L (feet)	layers	VERSA-Grid
4	0.5	4.5	2	VG 3.0
5	0.5	5.5	2	VG 3.0
6	0.5	6.0	3	VG 3.0
7	1.0	7.0	4	VG 3.0
8	1.0	7.5	5	VG 3.0
9	1.0	8.5	5	VG 3.0
10	1.0	9.0	6	VG 3.0
12	1.0	10.0	7	VG 5.0

Clay ($\phi = 28^\circ$)

H (feet)	D (feet)	L (feet)	layers	VERSA-Grid
4	0.5	5.5	2	VG 3.0
5	0.5	6.0	2	VG 3.0
6	0.5	6.5	3	VG 3.0
7	1.0	7.5	4	VG 3.0
8	1.0	8.0	5	VG 3.0
9	1.0	9.0	5	VG 3.0
10	1.0	9.5	6	VG 3.0
12	1.0	11.0	7	VG 5.0

*Geogrids with similar LTDS and connection strengths to VERSA-LOK units can also be estimated using these charts. With some variations, the VERSA-Grid VG 3.0 charts also generally estimate quantities for Miragrid 3XT, Stratagrid 300, and Raugrid 4/2. The charts for VERSA-Grid VG 5.0 generally estimate quantities for Miragrid 5XT, Stratagrid 500, and Raugrid 6/3.

Miragrid is a registered trademark of Nicolon Corporation. • Stratagrid is a registered trademark of Strata Systems, Inc. Raugrid is a trademark of Lückenhaus Technische Textilien GmbH and Lückenhaus North America, Inc.

VERSA-LOK® Accent® & Cobble®

VERSA-LOK Cobble or Accent units alone are an excellent option for near vertical or tight radius walls.

Design Options Using VERSA-LOK® Mosaic® Units

Attractive, durable retaining walls can be constructed using only VERSA-LOK Cobble or VERSA-LOK Accent units. These units offer the same features and benefits as VERSA-LOK Mosaic walls, including:

- **Classic split-face texture or Weathered™ Series**
- **Setback or near-vertical walls**
- **No mortar or concrete footings required**
- **Great options for tighter radius projects, such as planting areas and tree rings**

Maximum height for an unreinforced VERSA-LOK Accent or VERSA-LOK Cobble wall using a 3/4-inch setback is four feet. Maximum height for an unreinforced wall built with a near-vertical setback is two feet. Individual site, soil, and loading conditions (including terraces) may limit unreinforced wall heights to less than those stated. Taller walls require soil reinforcement and engineering assistance. Please contact your local VERSA-LOK representative if unsure about any site, soil, height, or local construction requirements.

Please refer to the design and construction procedures detailed in this manual when constructing your wall.

VERSA-LOK Accent

- 3' 0" Min. Outside Radius
- 1 Unit = 36 lbs.

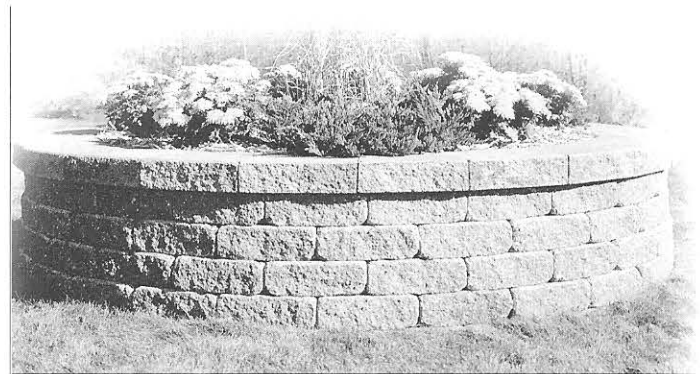
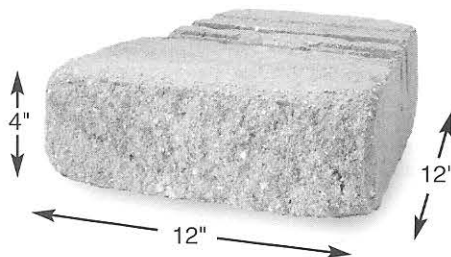

VERSA-LOK Cobble

- 4' 4" Min. Outside Radius
- 1 Unit = 38 lbs.

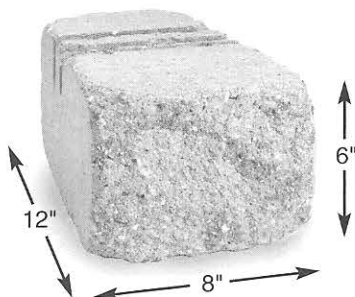

VERSA-LOK® Mosaic® Specifications

PART 1: GENERAL

1.01 DESCRIPTION

- A. *Work includes furnishing and installing segmental retaining wall (SRW) units to the lines and grades designated on the project's final construction drawings or as directed by the Architect/Engineer. Also included is furnishing and installing appurtenant materials required for construction of the retaining wall as shown on the construction drawings.*

1.02 REFERENCE STANDARDS

- A. *Segmental Retaining Wall Units*
1. **ASTM C 1372**
 - Standard Specification for Segmental Retaining Wall Units
 2. **ASTM C 140**
 - Standard Test Methods of Sampling and Testing Concrete Masonry Units
- B. *Geosynthetic Reinforcement*
1. **ASTM D 4595**
 - Tensile Properties of Geotextiles by the Wide-Width Strip Method
 2. **ASTM D 5262**
 - Test Method for Evaluating the Unconfined Creep Behavior of Geosynthetics
 3. **GRI:GG1**
 - Single Rib Geogrid Tensile Strength
 4. **GRI:GG5**
 - Geogrid Pullout
- C. *Soils*
1. **ASTM D 698**
 - Moisture Density Relationship for Soils, Standard Method
 2. **ASTM D 422**
 - Gradation of Soils
 3. **ASTM D 424**
 - Atterberg Limits of Soil
- D. *Drainage Pipe*
1. **ASTM D 3034**
 - Specification for Polyvinyl Chloride (PVC) Plastic Pipe
 2. **ASTM D 1248**
 - Specification for Corrugated Plastic Pipe

- E. *Engineering Design*
1. **"NCMA Design Manual for Segmental Retaining Walls," Second Edition**

- F. *Where specifications and reference documents conflict, the Architect/Engineer shall make the final determination of applicable document.*

1.03 SUBMITTALS

- A. **Material Submittals:** *The Contractor shall submit manufacturers' certifications two weeks prior to start of work stating that the SRW units and geosynthetic reinforcement meet the requirements of Section 2 of this specification.*
- B. **Design Submittal:** *The Contractor shall submit two sets of detailed design calculations and final retaining wall plans for approval at least two weeks prior to the beginning of wall construction. All calculations and drawings shall be prepared and sealed by a professional Civil Engineer (P.E.) – (Wall Design Engineer) experienced in SRW design and licensed in the state where the wall is to be built.*

1.04 DELIVERY, STORAGE AND HANDLING

- A. *Contractor shall check materials upon delivery to assure that specified type and grade of materials have been received and proper color and texture of SRW units have been received.*
- B. *Contractor shall prevent excessive mud, wet concrete, epoxies, and like materials that may affix themselves, from coming in contact with materials.*
- C. *Contractor shall store and handle materials in accordance with manufacturer's recommendations.*
- D. *Contractor shall protect materials from damage. Damaged materials shall not be incorporated into the retaining wall.*

Use these specifications as a guide to create your own project specifications for a premium segmental retaining wall.

VERSA-LOK® Mosaic® Specifications

PART 2: MATERIALS

2.01 SEGMENTAL RETAINING WALL UNITS

- A. SRW units shall be machine formed, Portland Cement concrete blocks specifically designed for retaining wall applications. SRW units currently approved for this project are:

VERSA-LOK Mosaic Retaining Wall System that includes three unit types: VERSA-LOK Standard units, VERSA-LOK Cobble® units and VERSA-LOK Accent® units, as manufactured by _____.

- B. Color of SRW units shall be _____.
- C. Finish of SRW units shall be split face.
- D. SRW unit faces shall be of straight geometry.
- (Optional – for Weathered Mosaic)
- D. Finish of SRW unit faces shall be weathered split-face: a straight faced unit that is mechanically split and tumbled to create rounded edges similar in appearance to worn stone.
- E. SRW unit heights shall be both four and six inches.
- F. SRW units shall be designed to stack in ten-inch high by 24-inch-wide "panels" consisting of the three SRW unit types that can be stacked in varied patterns to create a random look.
- G. SRW units (not including aggregate fill in unit voids) shall provide a minimum weight of 105 psf wall face area.
- H. SRW units shall be solid through the full depth of the unit.
- I. SRW units shall have a depth (front face to rear) to height ratio of 2:1, minimum.
- J. SRW units shall be interlocked with connection pins, which provide 3/4-inch setback from the unit below (four and six-inch high are stacked alternately, yielding an overall 8.5 degree cant from vertical).

- K. SRW units shall be capable of being erected with the horizontal gap between adjacent units not exceeding 1/4 inches.
- L. SRW units shall be capable being installed with a continuous, level course at every ten inches of height so geosynthetic reinforcement layers can be placed level within the wall face.
- M. SRW units shall be capable of providing overlap of units on each successive course of a corner so that walls meeting at corner are interlocked and continuous. SRW units that require corners to be mitered shall not be allowed.
- N. SRW units shall be sound and free of cracks or other defects that would interfere with the proper placing of the unit or significantly impair the strength or permanence of the structure. Cracking or excessive chipping may be grounds for rejection. Units showing cracks longer than 1/2" shall not be used within the wall. Units showing chips visible at a distance of 30 feet from the wall shall not be used within the wall.
- O. Concrete used to manufacture SRW units shall have a minimum 28 days compressive strength of 3,000 psi and a maximum moisture absorption rate, by weight, of Eight percent as determined in accordance with ASTM C140. Compressive strength test specimens shall conform to the saw-cut coupon provisions of ASTM C140.
- P. SRW units' molded dimensions shall not differ more than 1/8 inch from that specified, in accordance with ASTM C1372.

VERSA-LOK® Mosaic® Specifications

2.02 SEGMENTAL RETAINING WALL UNIT CONNECTION PINS

- A. SRW units shall be interlocked with VERSA-TUFF® Snap-Off Pins, 6.8 inches in height, with a section which can snap-off, yielding a 4.6 inch high pin. The pins shall consist of glass-reinforced nylon made for the expressed use with the SRW units supplied.

2.03 GEOSYNTHETIC REINFORCEMENT

- A. Geosynthetic reinforcement shall consist of geogrids or geotextiles manufactured as a soil reinforcement element. The manufacturers/suppliers of the geosynthetic reinforcement shall have demonstrated construction of similar size and types of segmental retaining walls on previous projects. The geosynthetic type must be approved one week prior to bid opening. Geosynthetic types currently approved for this project are: VERSA-Grid® geogrids.
- B. The type, strength, and placement location of the reinforcing geosynthetic shall be as determined by the Wall Design Engineer, as shown on the final, P.E. sealed retaining wall plans.

2.04 LEVELING PAD

- A. Material for leveling pad shall consist of compacted sand, gravel, or combination thereof (USCS soil types GP, GW, SP, & SW) and shall be a minimum of six inches in depth. Lean concrete with a strength of 200-300 psi and six inches thick maximum may also be used as a leveling pad material. The leveling pad should extend laterally at least a distance of six inches from the toe and heel of the lowermost SRW unit.

2.05 DRAINAGE AGGREGATE

- A. Drainage aggregate shall be angular, clean stone or granular fill meeting the following gradation as determined in accordance with ASTM D422

SIEVE SIZE	PERCENT PASSING
1 inch	100
3/4 inch	75-100
No. 4	0-60
No. 40	0-50
No. 200	0-5

2.06 DRAINAGE PIPE

- A. The drainage collection pipe shall be a perforated or slotted PVC, or corrugated HDPE pipe. The drainage pipe may be wrapped with a geotextile to function as a filter.
- B. Drainage pipe shall be manufactured in accordance with ASTM D 3034 and/or ASTM D 1248.

2.07 REINFORCED (INFILL) SOIL

- A. The reinforced soil material shall be free of debris. Unless otherwise noted on the final, P.E. sealed, retaining wall plans prepared by the Wall Design Engineer, the reinforced material shall consist of the inorganic USCS soil types GP, GW, SW, SP, SM, meeting the following gradation, as determined in accordance with ASTM D422:

SIEVE SIZE	PERCENT PASSING
4 inch	100
No. 4	20-100
No. 40	0-60
No. 200	0-35

- B. The maximum particle size of poorly-graded gravels (GP) (no fines) should not exceed 3/4 inch unless expressly approved by the Wall Design Engineer and the long-term design strength (LTDS) of the geosynthetic is reduced to account for additional installation damage from particles larger than this maximum.
- C. The plasticity of the fine fraction shall be less than 20.

VERSA-LOK[®] Mosaic[®] Specifications

PART 3: DESIGN PARAMETERS

3.01 SOIL

- A. The following soil parameters, as determined by the Owner's Geotechnical Engineer shall be used for the preparation of the final design:

	Unit Weight (γ) (pcf)	Internal Friction Angle (ϕ) (degrees)	Cohesion (c)
Reinforced Fill:	_____	_____	o
Retained Soil:	_____	_____	o
Foundation Soil:	_____	_____	_____

(If internal friction angles are not available for the above section, the specifier can provide the USCS soil type classification for the reinforced, retained, and foundation soils and/or attach the geotechnical investigation report for this project.)

- B. Should the actual soil conditions observed during construction differ from those assumed for the design, design shall be reviewed by the Wall Design Engineer at the Owner's Geotechnical Engineer's direction.

3.02 DESIGN

- A. The design analysis for the final, P.E. sealed retaining wall plans prepared by the Wall Design Engineer shall consider the external stability against sliding and overturning, internal stability, and facial stability of the reinforced soil mass and shall be in accordance with acceptable engineering practice and these specifications. The internal and external stability analysis shall be performed in accordance with the "NCMA Design Manual for Segmental Retaining Walls," using the recommended minimum factors of safety in this manual.
- B. External stability analysis for bearing capacity, global stability, and total and differential settlement shall be the responsibility of the Owner and the Owner's Geotechnical Engineer. Geotechnical Engineer shall perform bearing capacity, settlement estimates, and global stability analysis based on the final wall design provided by the Wall Design Engineer and coordinate any required changes with Wall Design Engineer.

- C. While vertical spacing between geogrid layers may vary, it shall not exceed 20 inches maximum in the wall design.
- D. The geosynthetic placement in the wall design shall have 100 percent continuous coverage parallel to the wall face. Gapping between horizontally adjacent layers of geosynthetic (partial coverage) will not be allowed.

PART 4: CONSTRUCTION

4.01 INSPECTION

- A. The Owner or Owner's Representative is responsible for verifying that the contractor meets all the requirements of the specification. This includes all submittals for materials and design, qualifications, and proper installation of wall system.
- B. Contractor's field construction supervisor shall have demonstrated experience and be qualified to direct all work at the site.

4.02 EXCAVATION

- A. Contractor shall excavate to the lines and grades shown on the project grading plans. Contractor shall take precautions to minimize over-excavation. Over-excavation shall be filled with compacted infill material, or as directed by the Engineer/Architect, at the Contractor's expense.
- B. Contractor shall verify location of existing structures and utilities prior to excavation. Contractor shall ensure all surrounding structures are protected from the effects of wall excavation. Excavation support, if required, is the responsibility of the Contractor.

4.03 FOUNDATION PREPARATION

- A. Following the excavation, the foundation soil shall be examined by the Owner's Engineer to assure actual foundation soil strength meets or exceeds the assumed design bearing strength. Soils not meeting the required strength shall be removed and replaced with infill soils, as directed by the Owner's Engineer.

VERSA-LOK® Mosaic® Specifications

- B. Foundation soil shall be proofrolled and compacted to 95 percent standard Proctor density and inspected by the Owner's Engineer prior to placement of leveling pad materials.

4.04 LEVELING PAD CONSTRUCTION

- A. Leveling pad shall be placed as shown on the final, P.E. sealed retaining wall plans with a minimum thickness of six inches. The leveling pad should extend laterally at least a distance of six inches from the toe and heel of the lower most SRW unit.
- B. Granular leveling pad material shall be compacted to provide a firm, level bearing surface on which to place the first course of units. Well-graded sand can be used to smooth the top 1/4-to 1/2-inch of the leveling pad. Compaction will be with mechanical plate compactors to achieve 95 percent of maximum standard Proctor density (ASTM D 698).

4.05 SRW UNIT INSTALLATION

- A. All SRW units shall be installed at the proper elevation and orientation as shown on the final, P.E. sealed wall plans and details on the construction plans or as directed by the Wall Design Engineer. The SRW units shall be installed in general accordance with the manufacturer's recommendations. The specifications and drawings shall govern in any conflict between the two requirements.
- B. For ease of installation, generally the base course of SRW units shall be all six-inch-high Standard units placed on the leveling pad. The units shall be leveled side-to-side, front-to-rear and with adjacent units, and aligned to ensure intimate contact with the leveling pad. The base course is the most important to ensure accurate and acceptable results. No gaps shall be left between the front of adjacent units. Alignment may be done by means of a string line or offset from base line to the back of the units. Placing panels of Mosaic directly on the leveling pad is also acceptable. In this case, the entire ten-inch-high course of panels must be installed before the level and alignment can be checked.

- C. All excess debris shall be cleaned from top of units.
- D. Mosaic panels shall be placed on the units below. Each panel shall be installed completely prior to installing horizontally adjacent panels. Each Mosaic panel shall be ten inches high by 24 inches wide, consisting of one Standard unit, one Cobble® unit, and two Accent® units. With each adjacent panel, the units at the bottom of the panels should be alternated from four-inch-high units to six-inch-high units. As an example, one panel shall have Accent units at the base of the panel with Standard and Cobble units on top. The next adjacent panel shall have the Standard and Cobble units at the bottom and Accent units on top. The order of the Cobble and Standard units shall be randomly mixed within the panels to avoid a repetitive pattern. The entire length of each ten-inch-high course of panels shall be installed before starting the next course of panels.
- E. Each unit in a Mosaic panel shall be pinned to the units below in the following manner: Two VERSA-TUFF® Pins shall be inserted through the pin holes of each unit into receiving slots in units below, creating an approximate 3/4-inch setback from the unit below. Pins shall be fully seated in the pin slot below. When pinning four-inch-high Accent units, the top two inches of the 6.8-inch-high pin will initially extend above the Accent unit. The top of the pin shall be snapped-off by hitting the top of the pin from the side. Once pinned, the units shall be pushed forward to remove any looseness in the unit-to-unit connection.
- F. Prior to placement of next course of panels, the level and alignment of the units shall be checked and corrected, where needed.
- G. The next course of panels shall be placed so that it is staggered at least four inches from the vertical joints between the panels below. The patterns in the Mosaic panels generally shall not line up with the course below. The bond of the panels shall be varied on subsequent courses to create a random look.
- H. Layout of curves and corners shall be installed in accordance with the wall plan details or in general accordance with SRW manufacturer's installation guidelines. Walls meeting at corners shall be interlocked by overlapping successive courses of panels. Special cor-

VERSA-LOK® Mosaic® Specifications

ner panels shall be installed such that both sides of the corner panels vertically align the upper and lower units to create ten-inch-high joints to butt against adjacent regular Mosaic panels. For each course of panels, the corner panels shall be installed first, then regular panels installed out from the corners.

- I. Procedures C. through G. shall be repeated until reaching top of wall units, just below the height of the cap units. Geosynthetic reinforcement, drainage materials, and reinforced backfill shall be placed in sequence with unit installation as described in Section 4.06, 4.07, and 4.08.

4.06 GEOSYNTHETIC REINFORCEMENT PLACEMENT

- A. All geosynthetic reinforcement shall be installed at the proper elevation and orientation as shown on the final, P.E. sealed retaining wall plan profiles and details or as directed by the Wall Design Engineer.
- B. At the elevations shown on the final plans, (after the units, drainage material, and backfill have been placed to this elevation) the geosynthetic reinforcement shall be laid horizontally on compacted infill and on top of the concrete SRW units, to within one inch of the front face of the unit below. Embedment of the geosynthetic in the SRW units shall be consistent with SRW manufacturer's recommendations. Correct orientation of the geosynthetic reinforcement shall be verified by the Contractor to be in accordance with the geosynthetic manufacturer's recommendations. The highest strength direction of the geosynthetic must be perpendicular to the wall face.
- C. Geosynthetic reinforcement layers shall be one continuous piece for their entire embedment length. Splicing of the geosynthetic in the design strength direction (perpendicular to the wall face) shall not be permitted. Along the length of the wall, horizontally adjacent sections of geosynthetic reinforcement shall be butted in a manner to assure 100 percent coverage parallel to the wall face.
- D. Tracked construction equipment shall not be operated directly on the geosynthetic reinforcement. A minimum of six inches of backfill is required prior to operation of

tracked vehicles over the geosynthetic. Turning should be kept to a minimum. Rubber-tired equipment may pass over the geosynthetic reinforcement at slow speeds (less than 5 mph).

- E. The geosynthetic reinforcement shall be free of wrinkles prior to placement of soil fill. The nominal tension shall be applied to the reinforcement and secured in place with staples, stakes, or by hand tensioning until reinforcement is covered by six inches of fill.

4.07 DRAINAGE MATERIALS

- A. Drainage aggregate shall be installed to the line, grades, and sections shown on the final P.E. sealed retaining wall plans. Drainage aggregate shall be placed to the minimum thickness shown on the construction plans between and behind units (a minimum of one cubic foot for each exposed square foot of wall face unless otherwise noted on the final wall plans).
- B. Drainage collection pipes shall be installed to maintain gravity flow of water outside the reinforced soil zone. The drainage collection pipe shall daylight into a storm sewer or along a slope, at an elevation lower than the lowest point of the pipe within the aggregate drain.

4.08 BACKFILL PLACEMENT

- A. The reinforced backfill shall be placed as shown in the final wall plans in the maximum compacted lift thickness of ten inches and shall be compacted to a minimum of 95 percent of standard Proctor density (ASTM D 698) at a moisture content within two percent of optimum. The backfill shall be placed and spread in such a manner as to eliminate wrinkles or movement of the geosynthetic reinforcement and the SRW units.
- B. Only hand-operated compaction equipment shall be allowed within three feet of the back of the wall units. Compaction within the three feet behind the wall units shall be achieved by at least three passes of a lightweight mechanical tamper, plate, or roller.

VERSA-LOK® Mosaic® Specifications

C. At the end of each day's operation, the Contractor shall slope the last level of backfill away from the wall facing and reinforced backfill to direct water runoff away from the wall face.

D. At completion of wall construction, backfill shall be placed level with final top of wall elevation. If final grading, paving, landscaping, and/or storm drainage installation adjacent to the wall is not placed immediately after wall completion, temporary grading and drainage shall be provided to ensure water runoff is not directed at the wall nor allowed to collect or pond behind the wall until final construction adjacent to the wall is completed.

4.09 SRW CAPS

A. SRW caps shall be properly aligned and glued to underlying units with VERSA-LOK concrete adhesive, a flexible, high-strength adhesive. Rigid adhesive or mortar are not acceptable.

B. Caps shall overhang the top course of units by 3/4 to one inch. Slight variation in overhang is allowed to correct alignment at the top of the wall.

4.10 CONSTRUCTION ADJACENT TO COMPLETED WALL

A. The Owner or Owner's Representative is responsible for ensuring that construction by others adjacent to the wall does not disturb the wall or place temporary construction loads on the wall that exceed design loads, including loads such as water pressure, temporary grades, or equipment loading. Heavy paving or grading equipment shall be kept a minimum of three feet behind the back of the wall face. Equipment with wheel loads in excess of 150 psf live load shall not be operated within ten feet of the face of the retaining wall during construction adjacent to the wall. Care should be taken by the General Contractor to ensure water runoff is directed away from the wall structure until final grading and surface drainage collection systems are completed.

VERSA-LOK[®] Mosaic[®] Construction Details

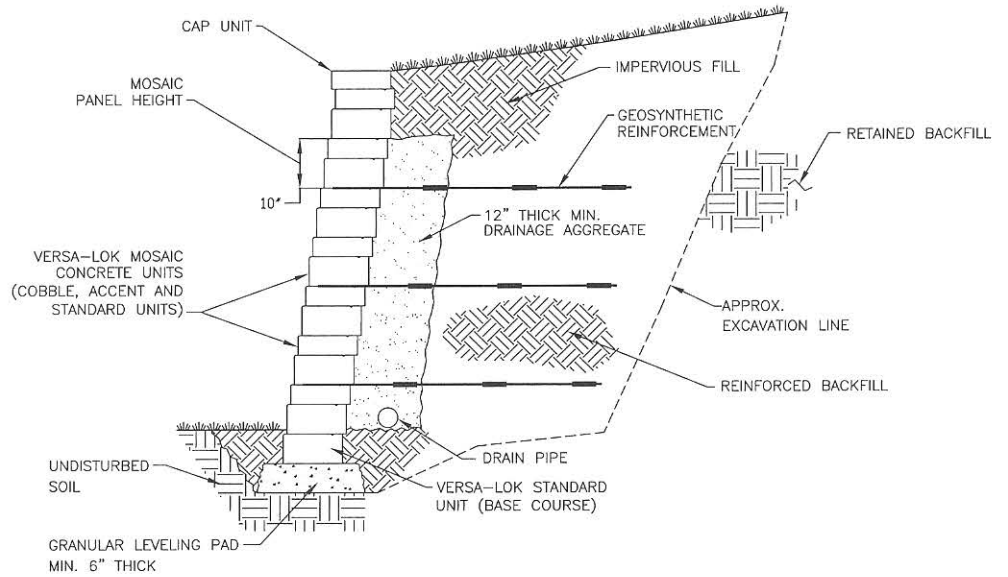

TYPICAL SECTION—REINFORCED RETAINING WALL

SCALE: NONE

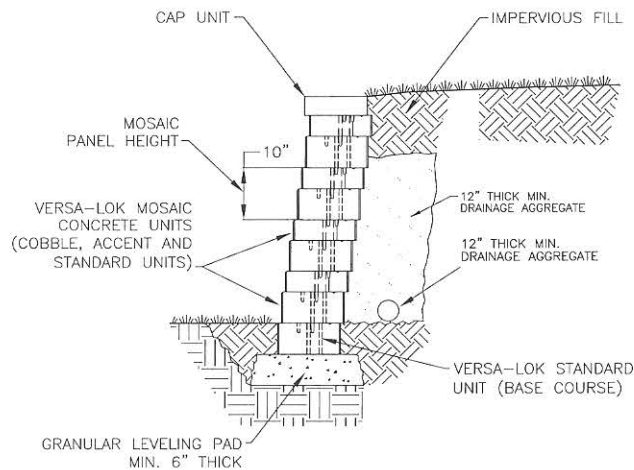

TYPICAL SECTION—UNREINFORCED RETAINING WALL

SCALE: NONE

VERSA-LOK[®] Mosaic[®] Construction Details

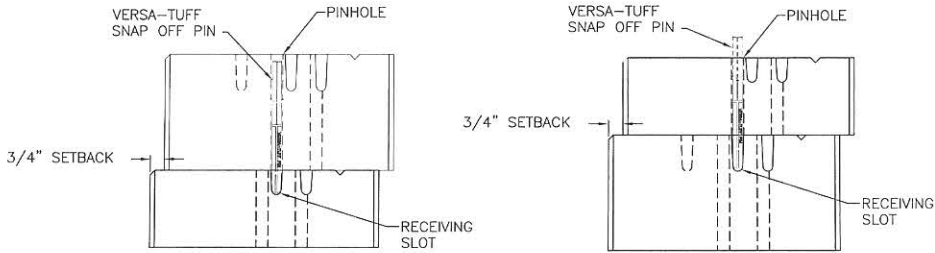

PINNING DETAIL

SCALE: NONE

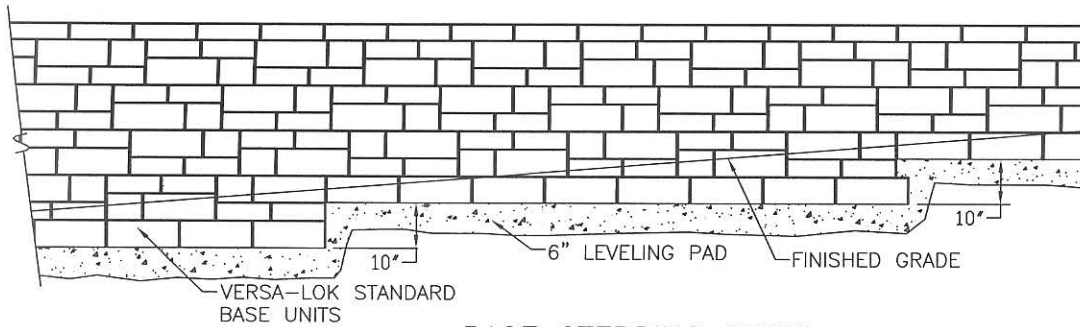

BASE STEPPING DETAIL

SCALE: NONE

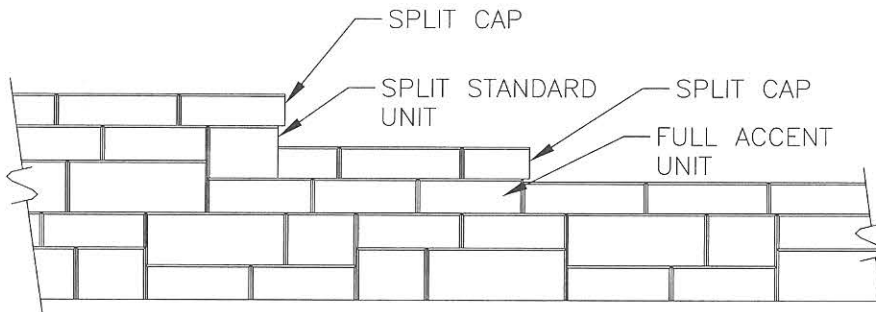

TOP STEPPING DETAIL

SCALE: NONE

VERSA-LOK[®] Mosaic[®] Construction Details

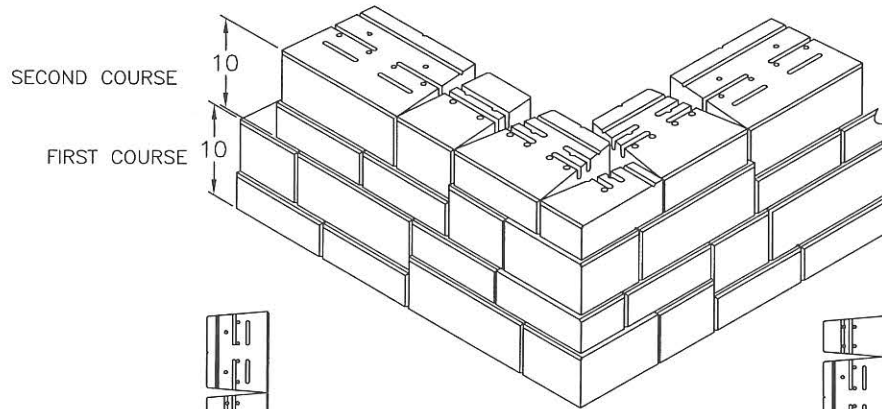

OUTSIDE 90° CORNER
SCALE: NONE

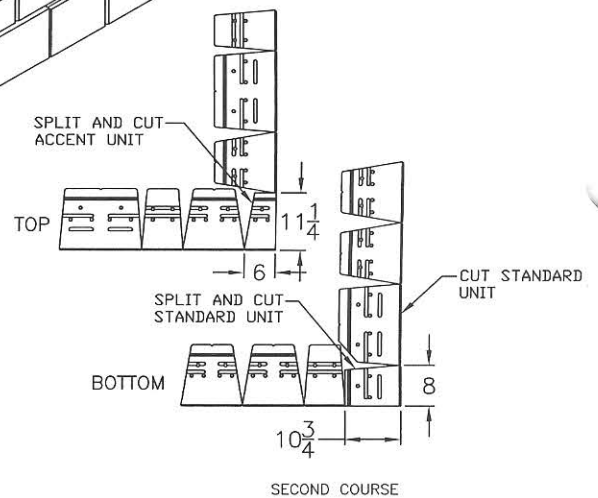
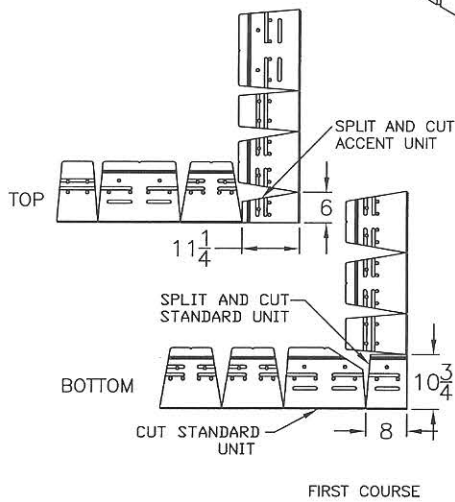

VERSA-LOK[®] Mosaic[®] Construction Details

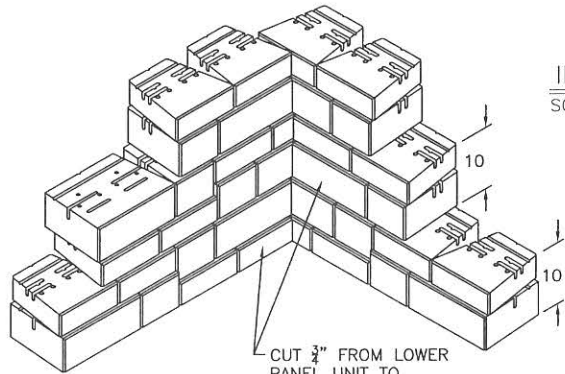

INSIDE 90° CORNER
SCALE: NONE

CUT $\frac{3}{4}$ " FROM LOWER
PANEL UNIT TO
ACCOMMODATE SETBACK
IN FACE OF ADJACENT
PANEL

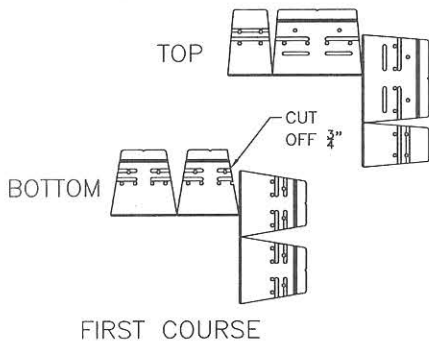

FIRST COURSE

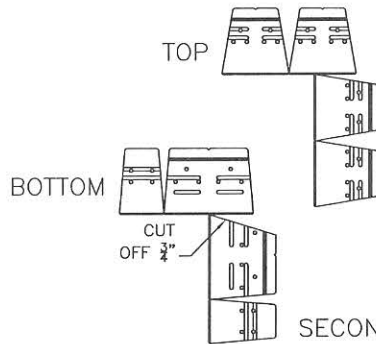

SECOND COURSE