

VERSA-LOK[®]

RETAINING WALL SYSTEMS

ST. LOUIS COUNTY MASTER PLANS VERSA-LOK RETAINING WALLS

KIRCHNER BLOCK AND BRICK
12901 St. Charles Rock Road
Bridgeton, MO 63044
314/291-3200

INDEX OF DRAWINGS:

Sheet 1	Title and Index
Sheet 2	Applications and Design Information
Sheet 3	Specifications
Sheet 4,5,6	Typical Details
Sheet 7	Standard Design - Horizontal Backfill
Sheet 8	Standard Design - Sloping Backfill
Sheet 9	Standard Design - Tiered Wall

APPLICATION

The Versa-lok retaining wall system is a reinforced soil structure combining an architecturally attractive concrete facing block with geogrid reinforcement. The geogrid reinforcement interlocks with the Versa-lok block units and fill soil to create a stable gravity retaining wall. Design of these reinforced soil structures uses well established guidelines that are readily available. The following specifications and details provide a design to incorporate geogrid reinforcement into the soil for the purposes of constructing retaining walls. Consult Kirchner Block and Brick for additional details regarding design, appearance, and aesthetic considerations.

STANDARD DESIGN PROCEDURE

The following design tables established for the construction of soil reinforced walls are based upon generally accepted soil parameters in the St. Louis County, Missouri area. An engineer shall review the site conditions and the soil present at the proposed location of the soil reinforced walls to determine if the actual conditions match the assumed parameters. All soil parameters assumed in the design are well drained, long term strength conditions. High plastic silts, and clays should be avoided without specific design recommendations from local geotechnical engineers. Frost heave and settlement need to be addressed if warranted by conditions. Also, special precautions are necessary for walls constantly in contact with water, i.e. near or at rivers, lakes, and ponds.

Three typical geometric cases were selected for these tables. The first case is a typical retaining wall with horizontal backfill, the second case is a 3:1 sloping backfill, and the third case is a tiered wall. All conditions are designed with 100 lb per sf surcharge. The following is a summary of the design parameters used and the minimum factors of safety which the tables are based on.

SOIL PROPERTIES:

	<u>Friction Angle</u>	<u>Unit Wt</u>	<u>Cohesion</u>
Wall fill	28	125	0
Retained Backfill	28	125	0
Foundation Soil	28	125	0
Friction Angle - degrees			
Unit Weight - lbs per cf			
Cohesion - lbs per sf			

MINIMUM FACTORS OF SAFETY CALCULATED

Reinforcement Pullout = 1.5
 Reinforcement Rupture = 1.5
 External Sliding = 1.5
 Overturning = 2.0
 Overall for Unknowns = 1.5
 Bearing Capacity = 2000 psf

SPECIFICATIONS FOR VERSA-LOK RETAINING WALL - St. Louis County Masterplan

Materials

Retaining wall units shall be Versa-lok block units as manufactured by Kirchner Block and Brick, Inc. The units are 16" wide x 6" tall with a split face finish. Concrete wall units shall meet the requirements of ASTM C90-90 except compressive strength shall be a minimum 3000 psi and the maximum water absorption shall be limited to 8.0 percent. The concrete shall have adequate freeze thaw resistance in accordance with ASTM C666-90.

The reinforced wall backfill material shall be compacted soil from on-site. The soil shall be free of clumps, free of rocks larger than 4", and free of organic materials. Do not use high plastic soils that have a PI>20 or LL>40.

Geogrids shall be Miragrid 2XT or 3XT as manufactured by Ten Cate Mirafi or Stratagrid SG150 or SG200 as manufactured by Strata Systems. The **geotextile filter fabric** shall be a nonwoven fabric with a minimum weight of 3.5 oz/sy.

The leveling pad shall be constructed of well graded crushed limestone similar to 1" minus.

The drainage rock shall be free draining rock such as 3/4" clean crushed limestone

Wall Foundation

Foundation soil shall be excavated as required for the leveling pad and the reinforced fill zone to the depths and locations shown on the plan sheet. The exposed foundation soil shall be observed by the prior to construction to verify that the exposed material is suitable for a net design bearing pressure of 2000 psf and that the base of the excavation is free of loose soil, uncompacted fill, water, or frozen material. Undercut any unsuitable soil. Undercut areas shall be filled with crushed limestone and compacted to at least 95% of the material's standard Proctor maximum dry density.

Construct the crushed rock leveling pad to lines and grades shown on the plans.

Construct the horizontal drainage layer at the lines and grades shown on the plans. The 6" of drainage rock shall be separated from the rock with a filter fabric.

Wall Construction

Install the first course of units on the leveling pad. Place the next units on top of the first units in a running bond pattern. Pull units forward. Install 2 pins through the top unit and into the receiving slot of the unit below. Backfill units and continue construction.

Cap units shall be glued in place at the top of the wall.

Drainage rock shall be placed directly behind the wall units a minimum 12" thick. The drainage rock shall be separated from the soil with a filter fabric.

Geogrid Reinforcing

The geogrids shall be cut to design lengths and placed between the blocks at the elevations shown on the plans. The geogrid's primary strength direction will be directed perpendicular to the wall face (into the fill.) The geogrids placed outside a plus or minus 4" zone of the geogrid design elevation will not be accepted. The geogrid shall be placed horizontally and lay flat on the reinforced fill soil. The geogrid shall be placed so that a minimum of 8" of grid is between the block layers. Slack in the geogrid shall be removed prior to placing additional backfill.

Wall Backfill

Wall backfill material shall be placed in maximum 8" loose lifts and compacted to at least 95% of the material's maximum dry density as determined by the standard Proctor method. Backfill shall be placed, spread, and compacted in such a manner that minimizes wrinkles and movement of the geogrid. Field density testing shall be conducted by a qualified soils technician to verify that at least the minimum degree of compaction is being obtained.

Place 12" of drainage rock behind units. Separate drainage rock and soil with the filter fabric.

During backfill placement the 3 foot zone directly behind the wall shall be limited to the use of hand operated compaction equipment only.

Construction equipment shall not be operated directly on the geogrid.

Protection of Work

The surface of the wall backfill shall be graded at the end of each day of work to provide positive surface drainage away from the wall. Grading shall include proper contouring of fills in adjacent areas to prevent the flow of surface water into the reinforced earth zone.

The design of the walls are based on conditions and loads imposed on the wall at completion of the project. Prior to project completion, the wall is vulnerable to damages caused by construction activity adjacent to the wall. Of particular concern is the of grading and pavement construction equipment on the retained backfill at the top of the wall. Only equipment with a weight not exceeding one ton can be used in the 3 foot zone directly behind the back of the wall face.

The soil in front of the walls shall be protected from future erosion.

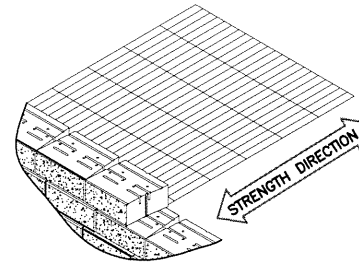
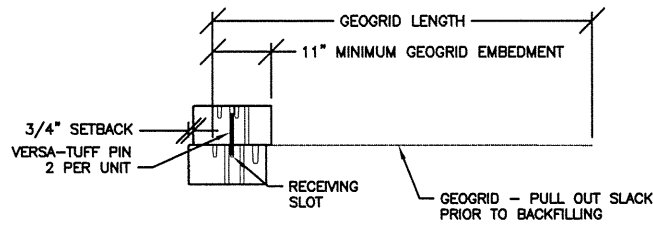

CONNECTION DETAIL
NOT TO SCALE

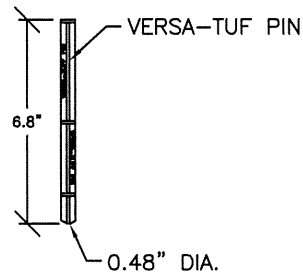

VERS-TUFF PIN
NOT TO SCALE

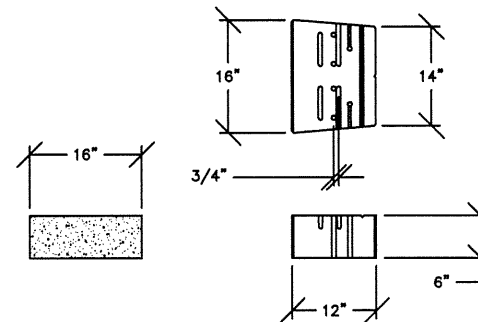

BLOCK DETAIL
NOT TO SCALE

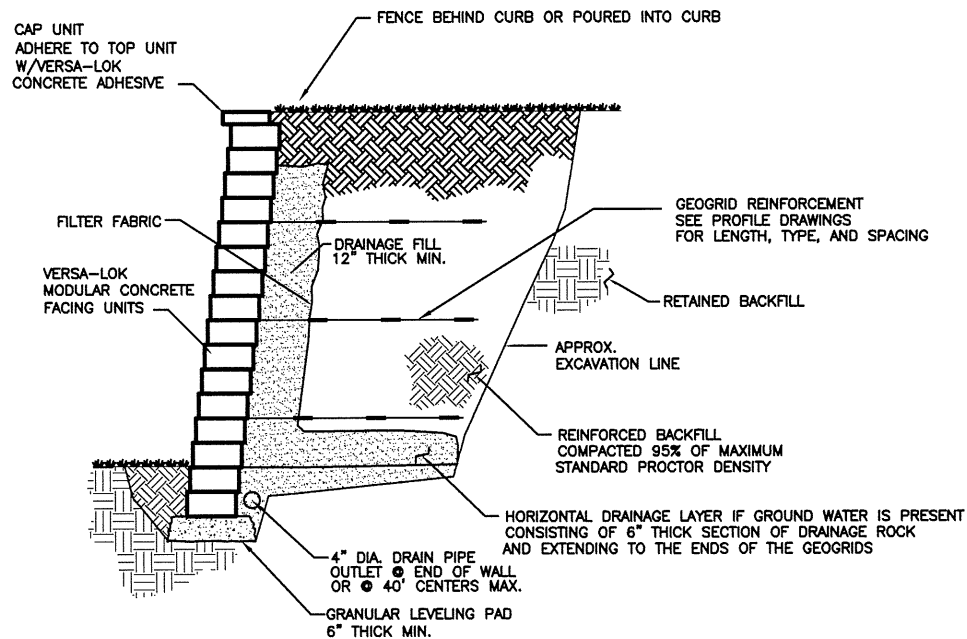

TYPICAL SECTION - REINFORCED WALL
NOT TO SCALE

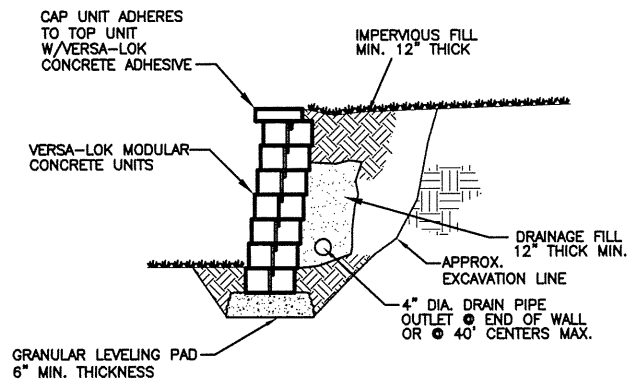

TYPICAL SECTION - UNREINFORCED RETAINING WALL
SOLID MORE

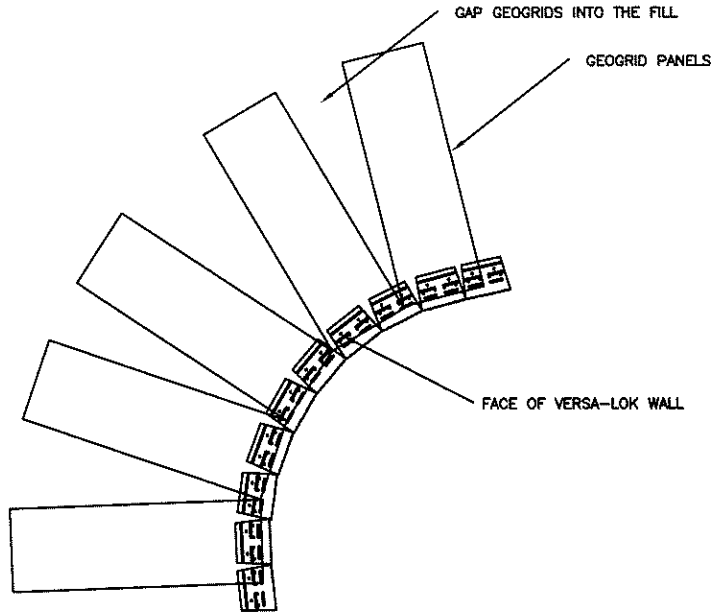

RADIUS WALL DETAIL
NOT TO SCALE

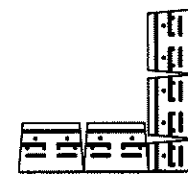

SECOND COURSE

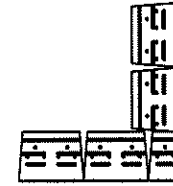

FIRST COURSE

CORNER DETAIL
90 DEGREE—OUTSIDE
SCALE: NONE

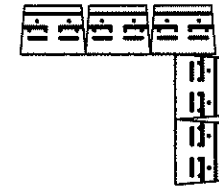

SECOND COURSE

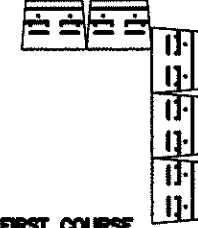

FIRST COURSE

CORNER DETAIL
90 DEGREE—INSIDE
SCALE: NONE

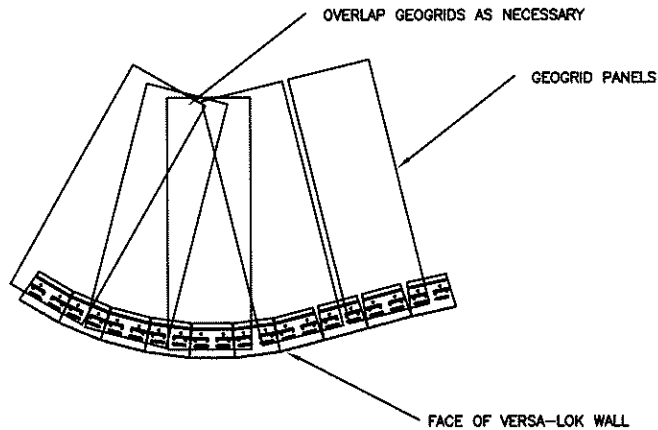

RADIUS WALL DETAIL
NOT TO SCALE

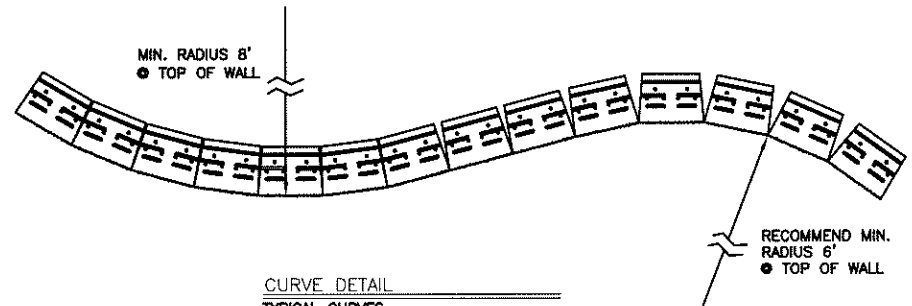

CURVE DETAIL
TYPICAL CURVES
NONE

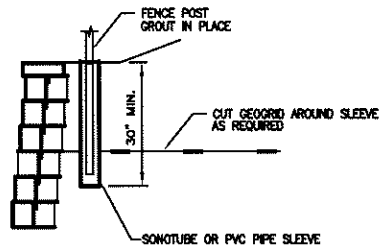

- PLACE SONOTUBE IN FILL AS THE BACKFILL IS BEING COMPACTED
- THE FENCE DESIGN AND ITS SUITABILITY IS THE RESPONSIBILITY OF OTHERS

FENCE POST DETAIL - IF REQUIRED

NOT TO SCALE

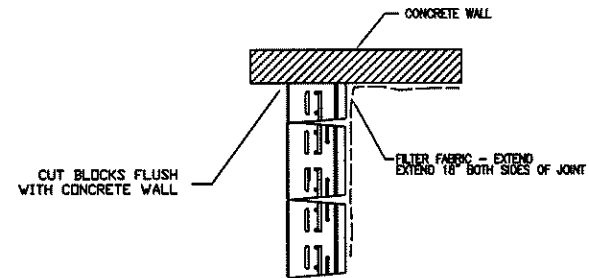

WALL ABUTMENT DETAIL

NOT TO SCALE

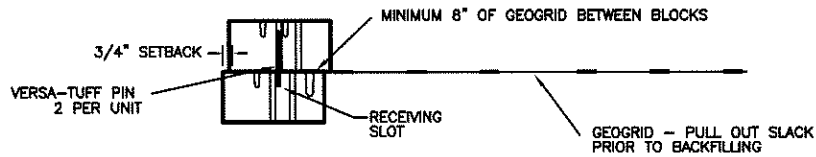

CONNECTION DETAIL

NOT TO SCALE

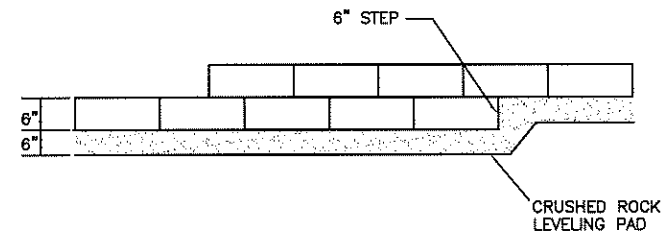

LEVELING PAD DETAIL

NOT TO SCALE

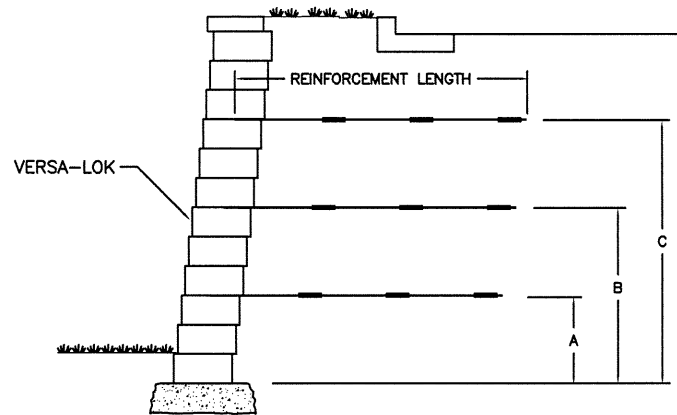

GEOGRID LAYOUT – PARKING SURCHARGE

SCALE NONE

Wall Height	Versa-lok Wall Units				
	# Geogrid Layers	Geogrid Length	A	B	C
2'	No geogrid required				
3'	1	3'	2'	-	-
4'	2	4'	2'	3'	-
5'	3	4'	1.5'	2.5'	4'
6'	4	4.5'	1.5'	3'	4.5'

All geogrids are to be Miragrid 2XT or 3XT or Stratgrid SG150 or SG200

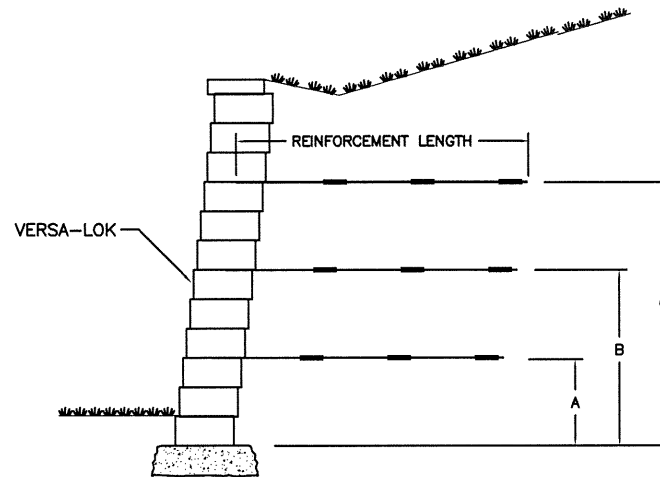

GEOGRID LAYOUT – SLOPING BACKFILL

SCALE: NONE

Wall Height	Versa-lok Wall Units				
	# Geogrid Layers	Geogrid Length	A	B	C
2'	No geogrid required				
3'	1	3'	1'	-	-
4'	2	4'	1'	2.5'	-
5'	2	4.5'	2'	3.5'	-
6'	3	5'	1'	3'	4.5'

All geogrids are to be Miragrid 2XT or 3XT or Stratgrid SG150 or SG200

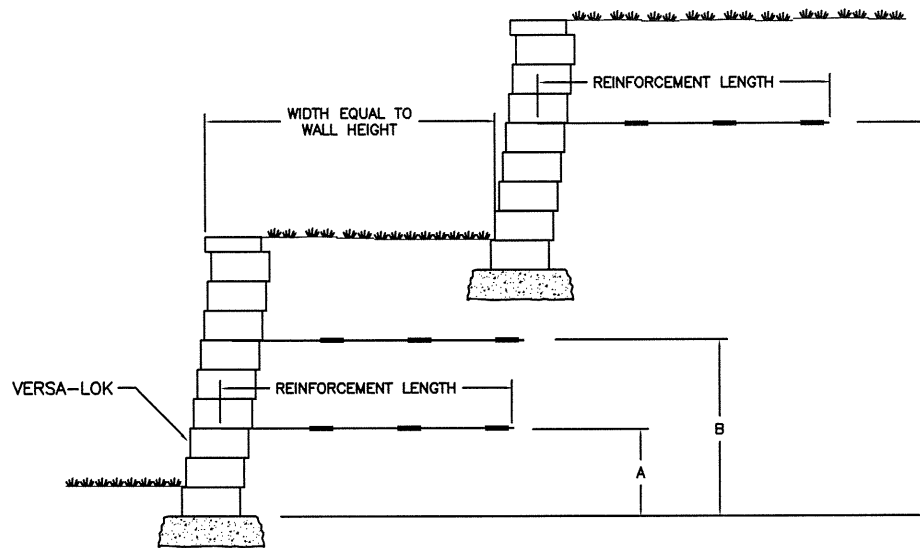

GEOGRID LAYOUT – TIERED WALL

SCALE: NONE

Wall Height (each wall)	Versa-lok Wall Units				
	# Geogrid Layers	Geogrid Length	A	B	C
2'	No geogrid required				
3'	2	3' both walls	2'	-	-
4'	4	4.5' bottom/4' top	1.5'	3'	6'

All geogrids are to be Miragrid 2XT or 3XT or Stratagrid SG150 or SG200