

**AMERICAN
MADE**

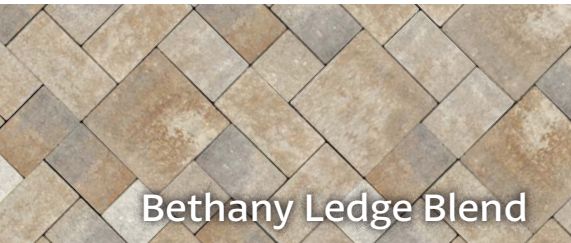

Pre-Ledge Rock™



Bethany Ledge Blend

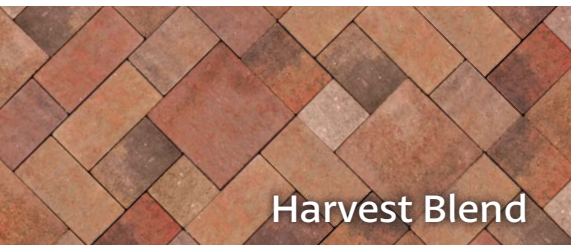

Harvest Blend

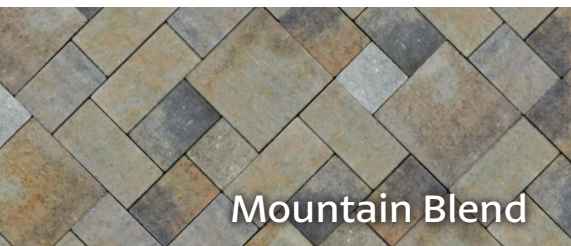

Mountain Blend

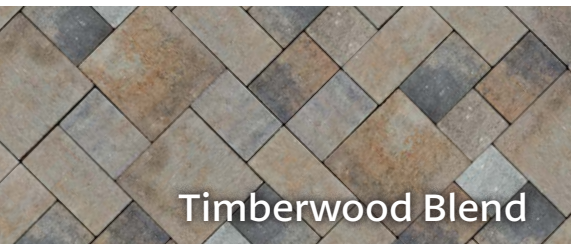

Timberwood Blend

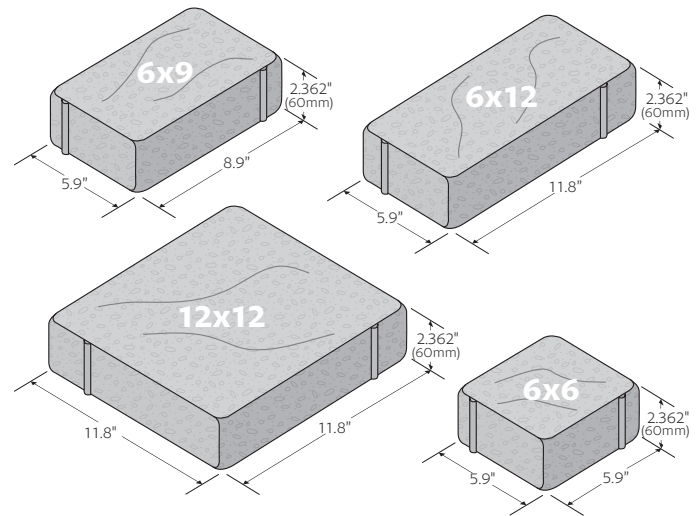

SIZE	UNITS/SQ. FT.	SQ. FT./PALLET	UNITS/PALLET	WEIGHT /PALLET
5.9" x 5.9" x 2.36" (60MM)	4.13	104.6	432	2,783 LBS
5.9" x 8.9" x 2.36" (60MM)	2.75	109.0	300	3,000 LBS
5.9" x 11.8" x 2.36" (60MM)	2.07	116.3	240	3,161 LBS
11.8" x 11.8" x 2.36" (60MM)	1.03	116.3	120	3,141 LBS

Pre-Ledge Rock™ comes in four sizes complimentary sizes. Use them to create patterns or a completely random look. Ledge Rock™ has a cut stone appearance that complements any outdoor setting.



Specifications

Pre-Ledge Rock™ is produced using a “no-s slump” concrete mix, made under extreme pressure and high frequency vibrations. Unit pavers will meet or exceed the requirements established in the ASTM C936 (standard specification for interlocking concrete paving units). Requirements of this standard include an average compressive strength of 8,000 psi, average absorption no greater than 5%.

**AMERICAN
MADE**

Laying Patterns

REPEATING PATTERN 1
33.3% 12 x12
33.3% 6 x12
25% 6 x9
8.3% 6 x6

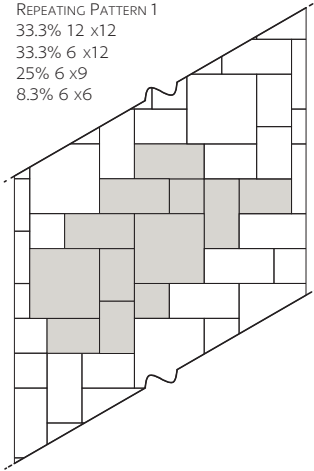

REPEATING PATTERN 2
25% 12 x12
62.5% 6 x12
12.5% 6 x6

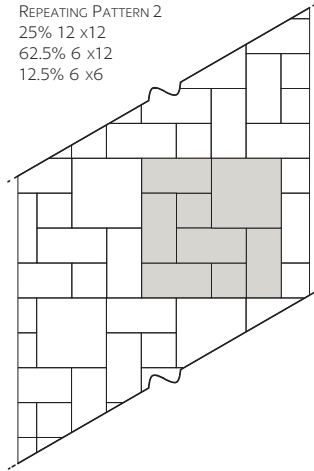

REPEATING PATTERN 3
80% 12 x12
20% 6 x6

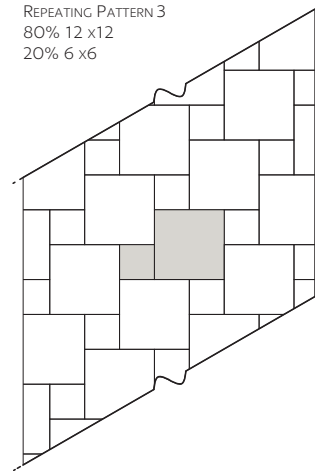

RANDOM PATTERN 4
12x12, 6 x12, 6 x9, 6 x6
PERCENTAGES VARY BY
CUSTOMER BASED
DECISIONS.

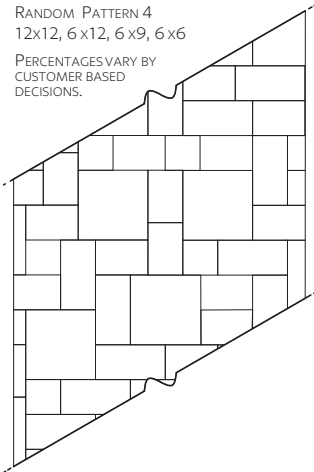

REPEATING PATTERN 5
25% 6 x6
75% 6 x9

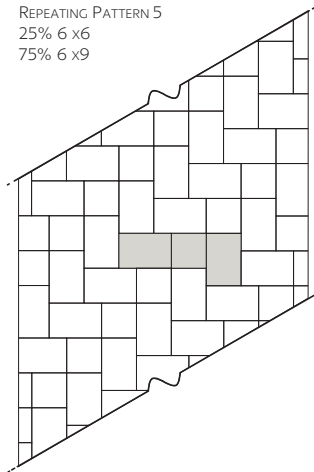

REPEATING PATTERN 6
25% 6x6
75% 6x9

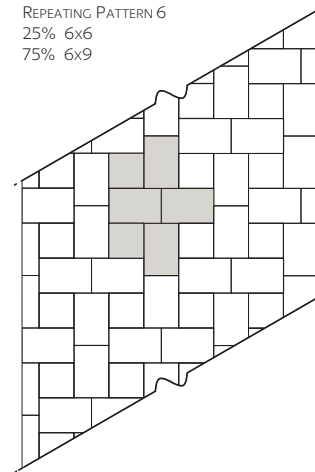

Available at:

ROMANSTONE
HARDSCAPES®

www.romanstone.com