



12901 St. Charles Rock Road
Bridgeton, MO 63044-2485
www.kirchnerblock.com
Phone: 314.291.3200
Fax: 314.291.0265

MASTER PLANS

Alpenstein Retaining Wall

- 12" Units/Single Tier/With Surcharge/Level Backfill - Plan #700-00-13
- 12" Units/Single Tier/Without Surcharge/Level Backfill - Plan #700-00-14
- 20" Units/Single Tier/With Surcharge/Level Backfill - Plan #700-00-15
- 20" Units/Single Tier/Without Surcharge/Level Backfill - Plan #700-00-16
- 12" Units/Single Tier/With Surcharge/Sloped Backfill - Plan #700-00-17
- 20" Units/Single Tier/With Surcharge/Sloped Backfill - Plan #700-00-18
- 12" & 20" Units/Double Tier/With Surcharge/Level Backfill - Plan #700-00-19

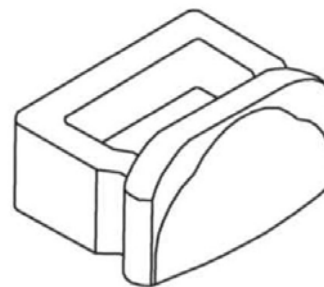
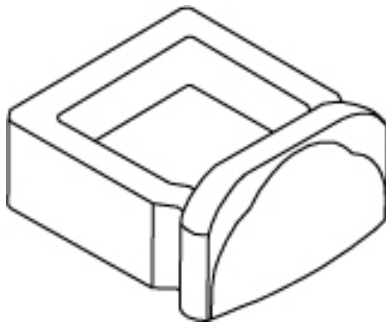

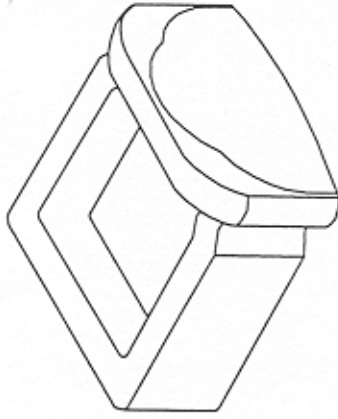

ALPENSTEIN[®]

RETAINING WALL SYSTEMS

MASTER PLANS
ALPENSTEIN RETAINING WALLS

KIRCHNER BLOCK AND BRICK, INC.
12901 St. Charles Rock Road
Bridgeton, MO 63044
314/291-3200
314/291-0265 fax

INDEX OF DRAWINGS

Sheet 1	Title and Index
Sheet 2	Alpenstein 12" and 20" Units
Sheet 3	Applications and Design Information
Sheet 4	Typical Cross-Sections
Sheet 5	Assembly and Layout Details
Sheet 6	Standard Design - Level Backfill
Sheet 7	Standard Design - Sloped Backfill
Sheet 8	Standard Design - Tiered Walls
Sheet 9	Specifications
Sheet 10	Specifications

Richard D. Laughlin, P.E.
MIDWEST TESTING, INC.
3377 Hollenberg Drive
Bridgeton, Missouri 63044
(314) 739-2727



ALPENSTEIN[®]
RETAINING WALL SYSTEMS

KIRCHNER BLOCK AND BRICK
12901 St. Charles Rock Road
Bridgeton, Missouri 63044
(314) 291-3200

TITLE PAGE

ST. LOUIS COUNTY MASTER PLANS
ALPENSTEIN RETAINING WALLS

Sheet: 1 of 10
Date: 4/3/00

ALPENSTEIN 12" UNIT

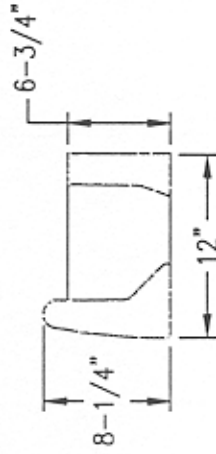

RIGHT SIDE

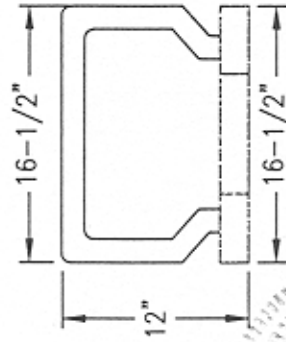

TOP SIDE

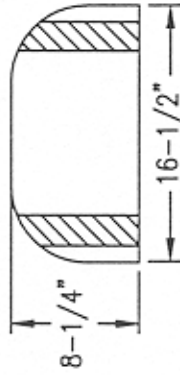

FRONT SIDE
(BOTH UNITS)

ALPENSTEIN 20" UNIT

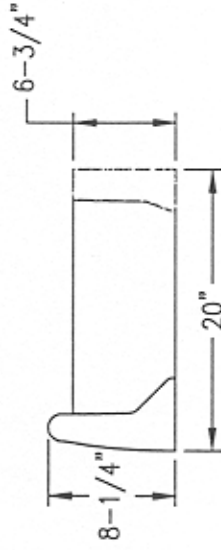

RIGHT SIDE

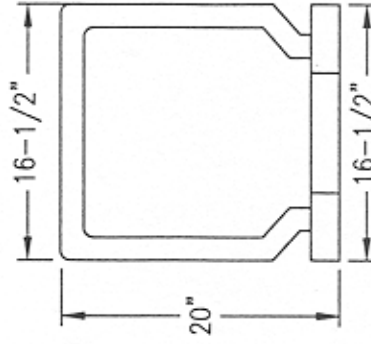

TOP SIDE



ALPENSTEIN®
RETAINING WALL SYSTEMS

Richard D. Laughlin, P.E.
MIDWEST TESTING, INC.
3377 Hollenberg Drive
Bridgeton, Missouri 63044
(314) 739-2727

KIRCHNER BLOCK AND BRICK
12901 St. Charles Rock Road
Bridgeton, Missouri 63044
(314) 291-3200

ALPENSTEIN BLOCK DIMENSIONS
ST. LOUIS COUNTY MASTER PLANS
ALPENSTEIN RETAINING WALLS
Sheet: 2 of 10
Date: 4/3/00

APPLICATION

The Alpenstein retaining wall consists of concrete wall units which are stacked to form a slope protection and/or retaining system. The open-unit design allows for root penetration and the natural infiltration of water. The walls can be built in straight lines, or in convex or concave curves. The following details and specifications provide standard designs for retaining walls with and without geogrid reinforcement.

STANDARD DESIGN PROCEDURE

The standard design details established for the construction of reinforced soil retaining walls are based upon generally accepted soil parameters for St. Louis County. A qualified engineer shall review the site and soil conditions to determine if the actual conditions match those used in this design. All soil parameters used in the design are under long-term, well-drained strength conditions.

The drawings and specifications address geogrid layout and drainage requirements for horizontal and sloping backfill for single walls, and two-tier walls with horizontal backfill. Each case includes a surcharge of 100 pounds per square foot (psf). The following parameters and requirements were used in the development of the designs depicted hereon:

RETAINING WALL DESIGN

Component	Total Unit Weight_pcf	Cohesion_psf	Friction Angle_°	Hydrostatic Pressure_psf
Reinforced wall fill	125	0	28	0
Retained fill	125	0	28	0
Foundation soil	125	0	28	0

Internal Stability of Wall

- Minimum factor of safety for geogrid strength 1.5
- Minimum factor of safety for geogrid pullout 1.5
- Wall-backfill interaction coefficient 0.8
- Wall-foundation soil interaction coefficient 0.8
- Percent coverage of geogrids 100
- Wall batter 20'

External Stability of Wall

- Factor of safety for sliding considerations 1.5
- Factor of safety for overturning considerations 2.0

External Loading

Surcharge load = 100 psf at top of wall or 3:1 slope above wall

Bearing Conditions

Maximum allowable net bearing pressure for the wall is 2000 psf on natural soil or compacted fill. The allowable net bearing pressure includes a factor of safety of at least 3 against a general bearing capacity failure.



ALPENSTEIN®
RETAINING WALL SYSTEMS

Richard D. Laughlin, P.E.
MIDWEST TESTING, INC.
3377 Hollenberg Drive
Bridgeton, Missouri 63044
(314) 739-2727

KIRCHNER BLOCK AND BRICK
12901 St. Charles Rock Road
Bridgeton, Missouri 63044
(314) 291-3200

DESIGN INFORMATION

ST. LOUIS COUNTY MASTER PLANS
ALPENSTEIN RETAINING WALLS

Sheet: 3 of 10
Date: 12/14/99

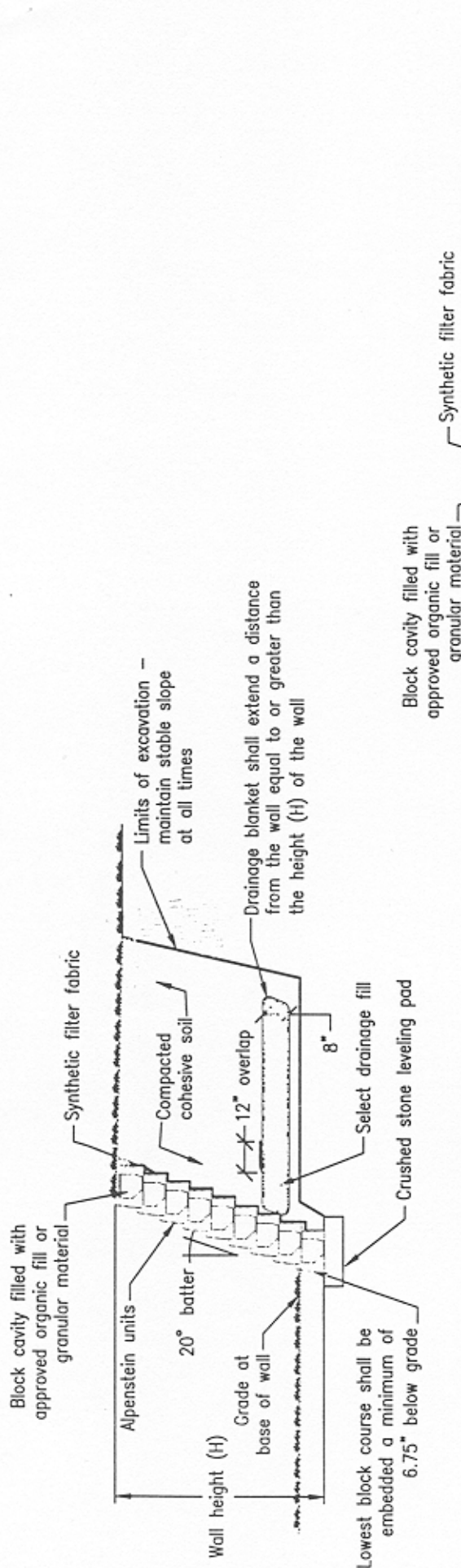

TYPICAL CROSS-SECTION - UNREINFORCED WALL
N.T.S.

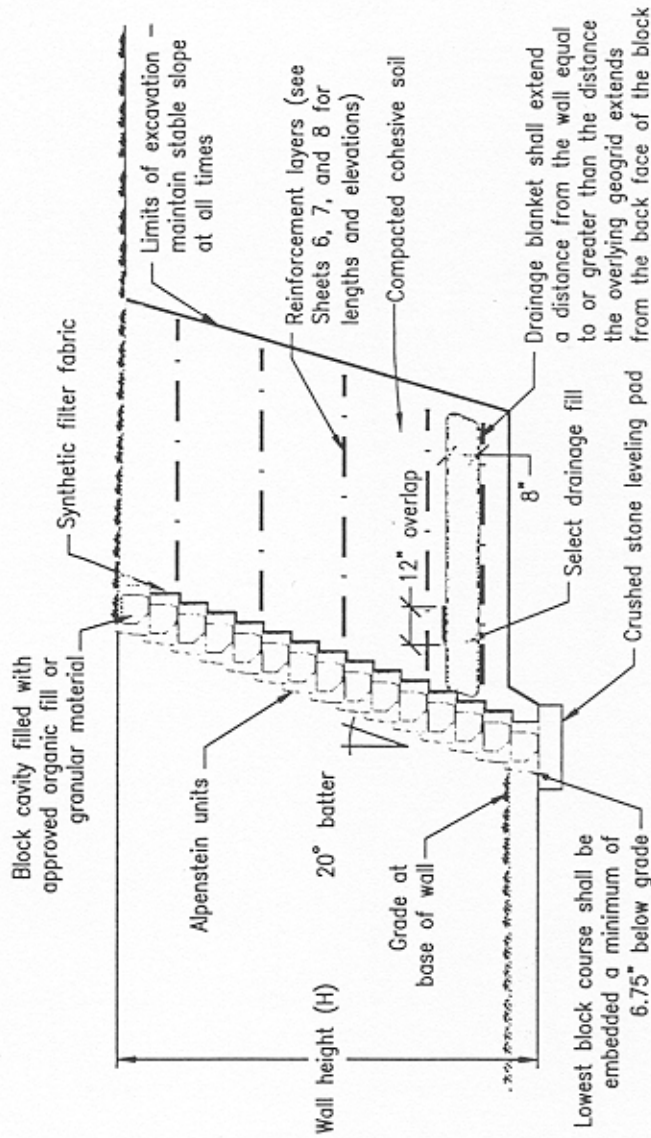

TYPICAL CROSS-SECTION - REINFORCED WALL
N.T.S.



ALPENSTEIN®
RETAINING WALL SYSTEMS

Richard D. Laughlin, P.E.
MIDWEST TESTING, INC.
3377 Hollenberg Drive
Bridgeton, Missouri 63044
(314) 739-2727

KIRCHNER BLOCK AND BRICK
12901 St. Charles Rock Road
Bridgeton, Missouri 63044
(314) 291-3200

TYPICAL CROSS-SECTIONS
ST. LOUIS COUNTY MASTER PLANS
ALPENSTEIN RETAINING WALLS

Sheet: 4 of 10
Date: 4/3/00

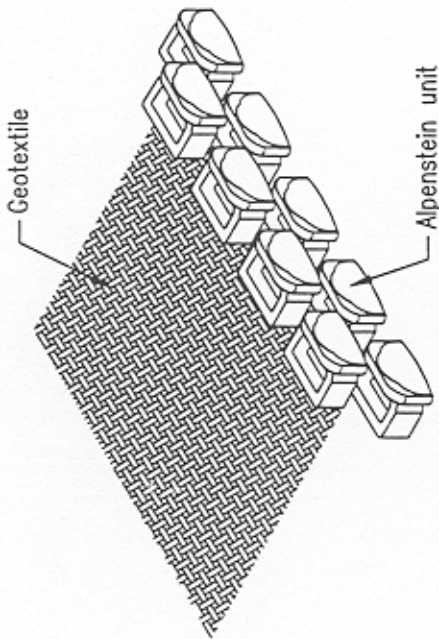

ISOMETRIC ASSEMBLY DETAIL
N.T.S.

Each course of block is offset from the underlying to form a cavity between units

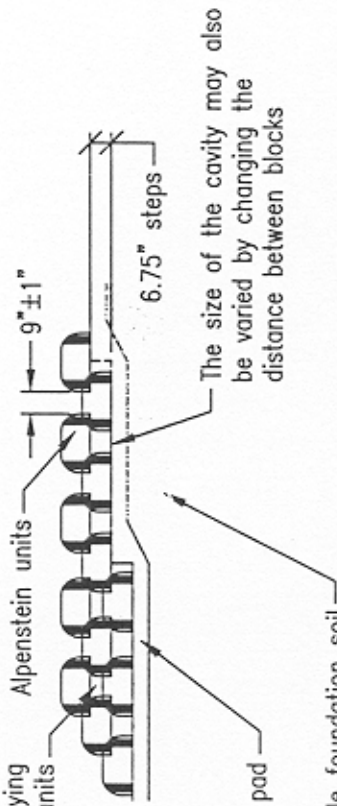

The size of the cavity may also be varied by changing the distance between blocks

WALL LAYOUT DETAIL
N.T.S.

Crushed rock leveling pad
Stable foundation soil

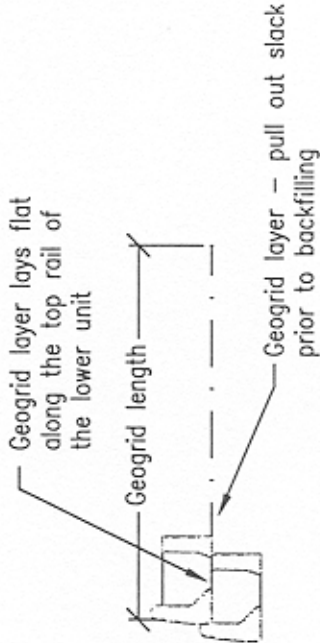

GEOGRID CONNECTION DETAIL
N.T.S.

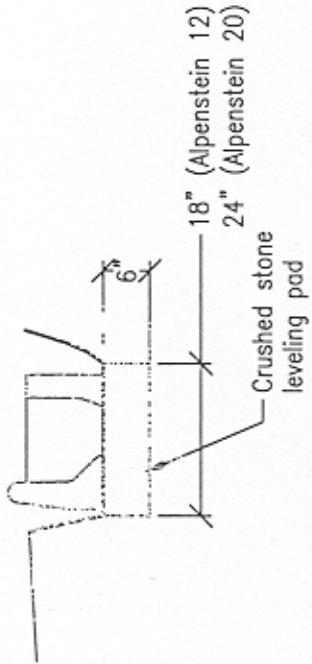

LEVELING PAD DETAIL
N.T.S.

ALPENSTEIN®
RETAINING WALL SYSTEMS

Richard D. Laughlin, P.E.
MIDWEST TESTING, INC.
3377 Hollenberg Drive
Bridgeton, Missouri 63044
(314) 739-2727

KIRCHNER BLOCK AND BRICK
12901 St. Charles Rock Road
Bridgeton, Missouri 63044
(314) 291-3200

ASSEMBLY AND LAYOUT DETAILS
ST. LOUIS COUNTY MASTER PLANS
ALPENSTEIN RETAINING WALLS

Sheet: 5 of 10
Date: 4/3/00

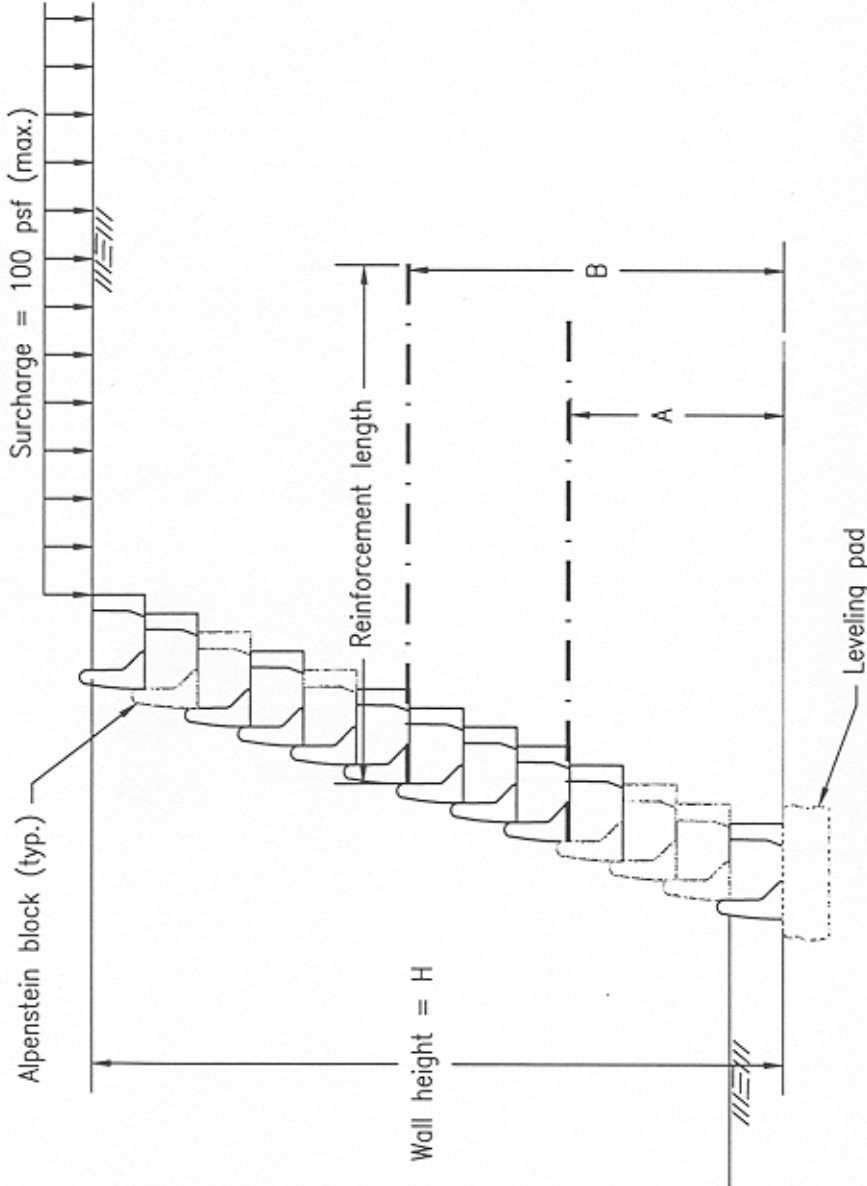

WITH SURCHARGE (S=100 psf max.)

Block Type	Maximum Unreinforced Height Above Grade (ft)	Total Number of Block Courses
Alpenstein 12"	2	5
Alpenstein 20"	5	10

WITHOUT SURCHARGE (S=0 psf)

Block Type	Maximum Unreinforced Height Above Grade (ft)	Total Number of Block Courses
Alpenstein 12"	4	8
Alpenstein 20"	6	12

Note: The 'no surcharge' case (S=0) can be used when the surcharge exists at a distance behind the top of the wall greater than or equal to the wall height.

Approximate Wall Height Above Grade (ft)	Total Number of Block Courses	Number of Reinforcement Layers	Reinforcement Length (ft)	A		B	
				Ft	Blocks	Ft	Blocks
3*	6	1	3.0	1.69	3	-	-
4*	8	1	3.5	1.69	3	-	-
5*	10	2	4.0	2.25	4	3.94	7
6**	12	2	4.0	2.25	4	3.94	7

*Using Alpenstein 12" units

**Using Alpenstein 12" units with or without surcharge, or Alpenstein 20" units with surcharge



ALPENSTEIN®
RETAINING WALL SYSTEMS

Richard D. Laughlin, P.E.
MIDWEST TESTING, INC.
3377 Hollenberg Drive
Bridgeton, Missouri 63044
(314) 739-2727

KIRCHNER BLOCK AND BRICK
12901 St. Charles Rock Road
Bridgeton, Missouri 63044
(314) 291-3200

REINFORCEMENT LAYOUT - LEVEL BACKFILL
ST. LOUIS COUNTY MASTER PLANS
ALPENSTEIN RETAINING WALLS
Sheet: 6 of 10
Date: 4/3/00

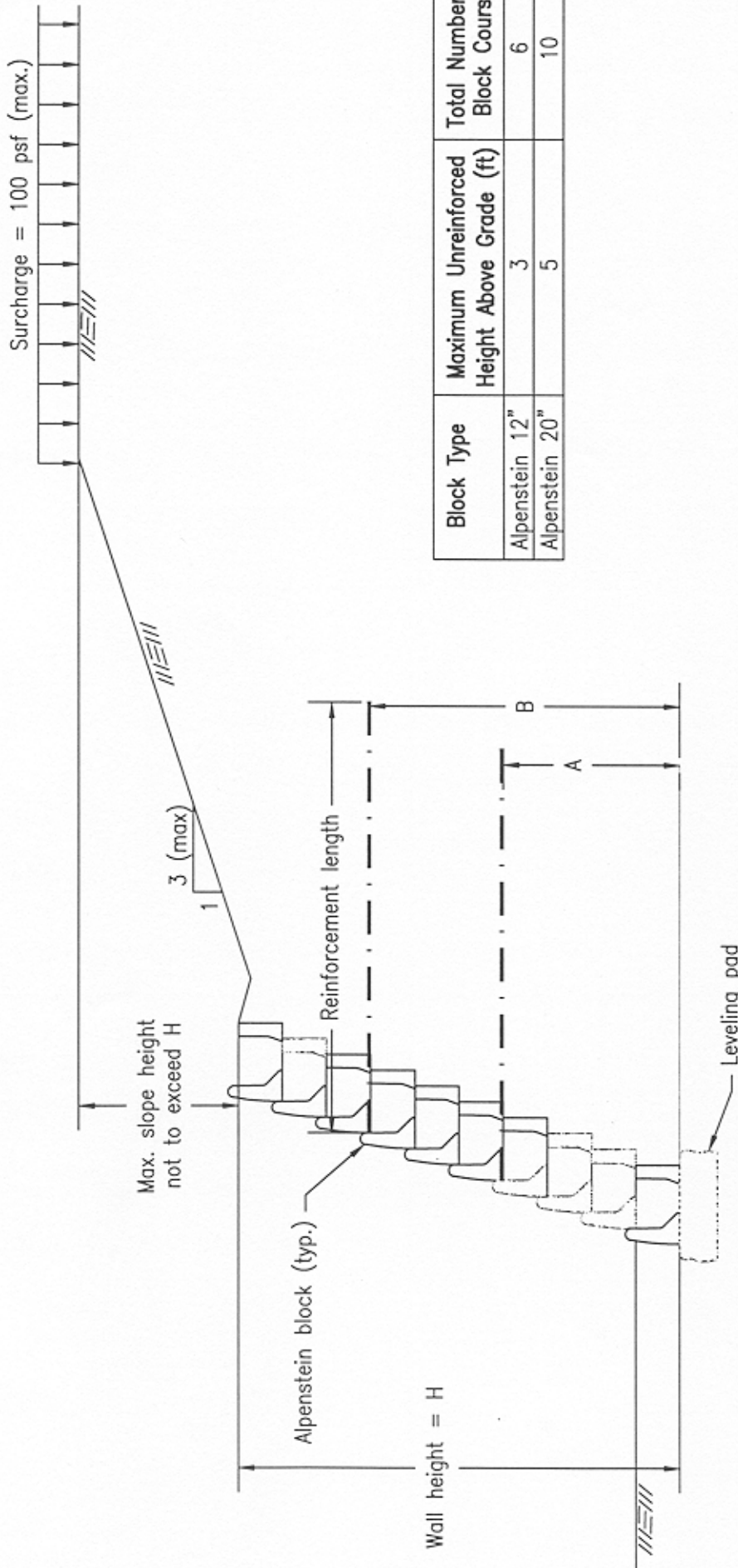

Block Type	Maximum Unreinforced Height Above Grade (ft)	Total Number of Block Courses
Alpenstein 12"	3	6
Alpenstein 20"	5	10

Approximate Wall Height Above Grade (ft)	Total Number of Block Courses	Number of Reinforcement Layers	Reinforcement Length (ft)	A		B	
				Ft	Blocks	Ft	Blocks
4*	8	1	3.5	1.69	3	-	-
5*	10	2	4.0	2.25	4	3.94	7
6**	12	2	4.0	2.25	4	3.94	7

*Using Alpenstein 12" units
 **Using Alpenstein 12" units or Alpenstein 20" units

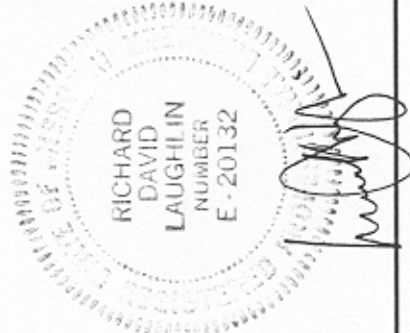

ALPENSTEIN®
 RETAINING WALL SYSTEMS

Richard D. Laughlin, P.E.
 MIDWEST TESTING, INC.
 3377 Hollenberg Drive
 Bridgeton, Missouri 63044
 (314) 739-2727

KIRCHNER BLOCK AND BRICK
 12901 St. Charles Rock Road
 Bridgeton, Missouri 63044
 (314) 291-3200

REINFORCEMENT LAYOUT - SLOPED BACKFILL
 ST. LOUIS COUNTY MASTER PLANS
 ALPENSTEIN RETAINING WALLS
 Sheet: 7 of 10
 Date: 4/3/00

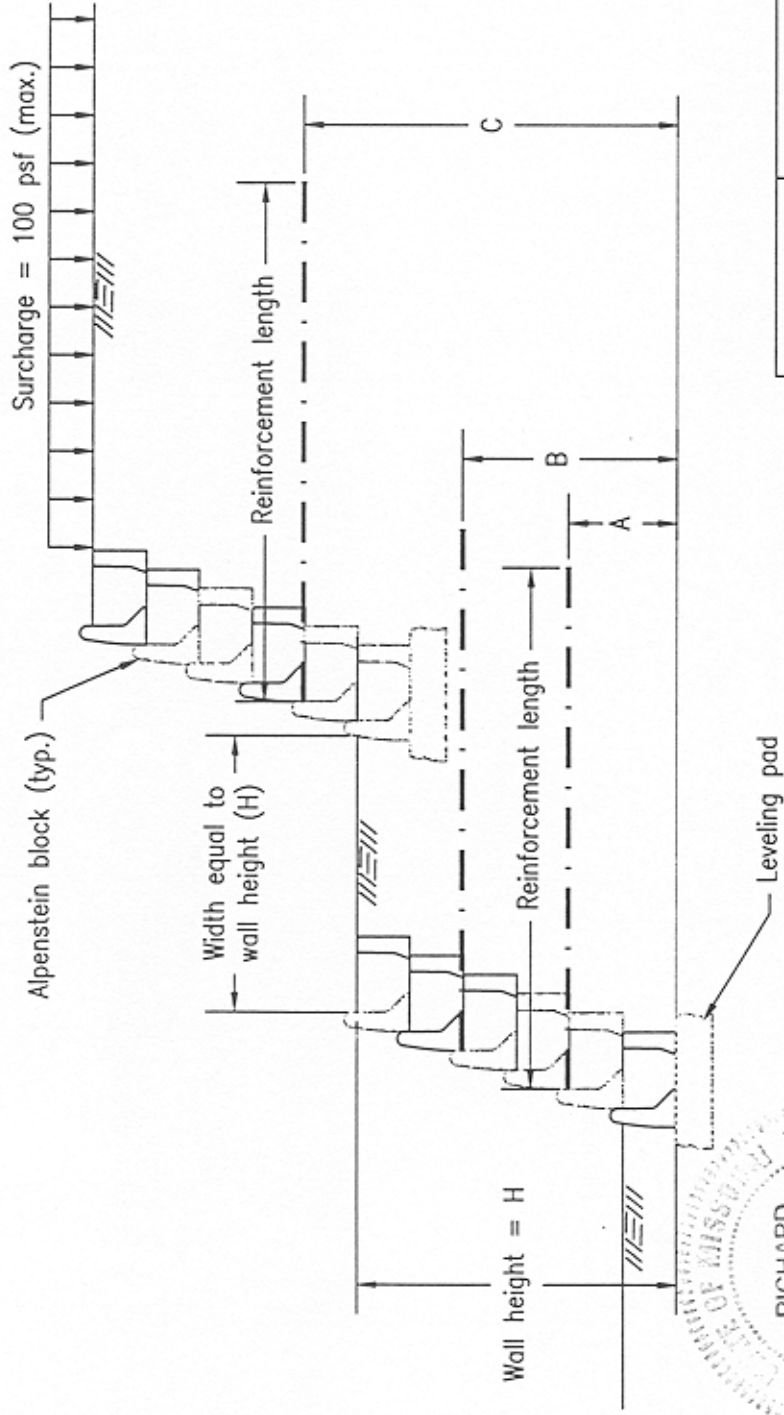

Block Type	Maximum Unreinforced Height Above Grade (ft)	Total Number of Block Courses
Alpenstein 12"	2	5
Alpenstein 20"	2	5

Approximate Wall Height Above Grade, each wall (ft)	Total Number of Block Courses, each wall	Number of Reinforcement Layers	Reinforcement Length (ft)	A (lower wall)		B (lower wall)		C (upper wall)	
				Ft	Blocks	Ft	Blocks	Ft	Blocks
3	7	3	4.0	1.69	3	2.81	5	5.06	9
4	8	3	4.0	1.13	2	3.38	6	5.63	10



ALPENSTEIN® RETAINING WALL SYSTEMS	KIRCHNER BLOCK AND BRICK 12901 St. Charles Rock Road Bridgeton, Missouri 63044 (314) 291-3200	REINFORCEMENT LAYOUT - TIERED WALLS ST. LOUIS COUNTY MASTER PLANS ALPENSTEIN RETAINING WALLS
	Richard D. Laughlin, P.E. MIDWEST TESTING, INC. 3377 Hollenberg Drive Bridgeton, Missouri 63044 (314) 739-2727	Sheet: 8 of 10 Date: 12/30/99

MATERIALS

Retaining wall units shall be Alpenstein 12 or Alpenstein 20 block units, as manufactured by Kirchner Block & Brick, Inc. The Alpenstein block units are 16.5 inches wide by 6.75 inches high with a front height of 8.25 inches. The Alpenstein 12 blocks are 12 inches deep and weigh approximately 58 pounds each. The Alpenstein 20 blocks are 20 inches deep and weigh approximately 79 pounds each. The concrete used to construct the units shall have a minimum 28-day compressive strength of 3000 psi in accordance with ASTM C 90. Materials shall be protected at the job site and kept free from damage prior to installation.

Geotextile reinforcement material shall consist of Mirafi SRW200 manufactured by TC Mirafi. Synthetic filter fabric surrounding the blanket drains and lining the back face of the blocks shall be Mirafi 140NL. Reinforcing material shall be stored above -20°F and be shaded from prolonged exposure to direct sunlight. Rolled reinforcing material may be laid flat or stood on end for storage. Contractor shall prevent mud, wet cement, epoxy, and like materials from coming in contact with or affixing themselves to the geotextile or geotextile products.

The retaining wall leveling course shall consist of 3/4- to 1-inch minus (at least 15 percent by weight passing the No. 200 sieve) durable crushed stone.

Reinforced wall backfill material shall be cohesive soil with a liquid limit not to exceed 45 and a plasticity index (PI) less than 20. The material shall be free of rubble, boulders, cobbles, and gravel, and not contain more than 5 percent organic matter by weight.

The select drainage fill shall be 3/4- to 1-inch clean (less than 5 percent by weight passing the No. 200 sieve) durable crushed stone.

The topsoil shall be fertile, friable, and fibrous (containing a minimum of 4% organic matter). The topsoil shall be free of rubble, stones larger than 1 inch in diameter, frozen material, and seeds from noxious weeds.

EXECUTION

Foundation Soil Preparation

Vegetation and topsoil shall be removed in the area of the reinforced fill zone. Excavate material for the wall as required to achieve the required reinforcement length and leveling pad depth, such that the lowest block course is embedded a minimum of 6.75 inches (one block course) below the finished grade at the base of the wall at all locations.

Foundation soil shall be excavated as required to expose natural undisturbed soil or compacted fill suitable for the support of the wall at the maximum design bearing pressure of 2000 psf. The base of the excavation shall be free of loose soil or rock, uncompacted fill, water, frozen material, or other deleterious matter. If uncompacted fill or other unsuitable soil is encountered at the base of the

excavation, the base of the reinforced zone shall be undercut a minimum of 2 feet below the grade at the base of the wall and replaced with compacted material, in accordance with compaction requirements set forth elsewhere in these specifications.

Wall Erection

Construct the crushed rock leveling pad as shown in the detail drawing. The leveling pad shall be at least 6 inches thick after compaction. The leveling pad shall extend at least 3 inches beyond the front and back edges of the first block course.

The initial block course must be carefully positioned to ensure proper wall alignment. To ensure that the block units are properly aligned, a thin veneer of fine- to medium-grained sand not to exceed 1 inch in thickness may be spread over the prepared footing to aid in leveling and provide full contact with the prepared footing. Install first course of wall units at a minimum depth of 6.75 inches below grade on the prepared leveling pad. The horizontal distance between adjacent blocks should be 9±1 inches in order to maximize contact between successive block layers.

Block units shall remain below grade a minimum of 6.75 inches at all locations and be "stepped" where necessary to accommodate sloping grades. The maximum vertical step should not exceed 2 block courses.

Install next course by stacking tightly against the shield of the lower block in a running bond pattern, resulting in an inclination of 20° to the vertical. Maintain a horizontal spacing of 9±1 inches between adjacent blocks for straight walls. Horizontal spacing for concave or convex walls will vary for successive block courses but shall not exceed 10 inches.

See specifications elsewhere on this sheet for geotextile installation procedures.

The alignment and inclination of the wall must be inspected frequently during construction and adjusted as necessary to maintain proper alignment. Blocks may be leveled using mortar as fill between blocks or durable, non-degradable shims may be used as needed.

Wall Drainage

Install the blanket drain for the length of the wall as shown on the detail drawing. The blanket drain shall be installed above the grade at the base of the wall. Install synthetic filter fabric around the 6-inch-thick layer of select drainage fill and along the back face of the wall as construction proceeds to prevent the migration of soil fines into the drainage material and through the openings between blocks. The front edge of the blanket drain shall maintain full contact with the back of the block. A minimum of 3 inches of reinforced backfill shall be present between the fabric-wrapped blanket drain and any geotextile layer.

Finished grading shall be performed such that positive drainage is established. The water shall sheet-flow over the top of the wall, flow away from the wall, or be directed around the wall, such as with a swale. Grading shall be performed near the

ALPENSTEIN®
RETAINING WALL SYSTEMS

Richard D. Laughlin, P.E.
MIDWEST TESTING, INC.
3377 Hollenberg Drive
Bridgeton, Missouri 63044
(314) 739-2727

KIRCHNER BLOCK AND BRICK

12901 St. Charles Rock Road
Bridgeton, Missouri 63044
(314) 291-3200

SPECIFICATIONS

ST. LOUIS COUNTY MASTER PLANS
ALPENSTEIN RETAINING WALLS

Sheet: 9 of 10

Date: 4/3/00

base of the wall to establish a slope such that water will flow away from the base of the wall.

Filling and Compaction

Filling behind the wall and within the block cavities shall proceed as the wall is constructed. The height of the wall shall be kept not more than 2 block courses above the level of the backfill.

Place reinforced wall backfill material in maximum 8-inch-thick loose lifts and compact to at least 95 percent of the material's maximum dry density as determined by the standard Proctor method (ASTM D 698). The moisture content of the backfill material must be within the range conducive for achieving the required compaction, which may require aeration or the addition of water depending on the moisture conditions prevailing at the time of construction.

Backfill shall be placed, spread, and compacted in such a manner that minimizes wrinkles and movement of the geotextile. Backfill shall be placed from the wall outward to ensure that the geotextile remains taut during the backfilling operation.

Fill materials shall be placed to lines and grades shown on construction plans. Tolerance of variations with grades shown shall be plus or minus 0.1 feet.

Topsoil or crushed stone used within the cavities of the blocks shall be tamped into place using a hand tamper.

Fill materials classified as cohesive and granular shall not be mixed.

Geotextile Reinforcement

Refer to the construction drawings for required type, length, and elevation of geotextile layers. When cut in the field, geotextile layers can have a minimum tolerance of the specified length minus 3 inches. Lengths shorter than this minimum will be rejected. The geotextile lengths shown on the plans include the portion of the geotextile layer to be embedded between the block courses.

The placement of the geotextiles is shown on the construction drawings. Monitoring of the fill will be necessary to ensure that the geotextiles are placed at the specified elevation. Geotextiles placed outside of a plus or minus 4-inch zone of the geotextile design elevation will not be accepted. Removal of unacceptably placed geotextiles will be required so that proper elevations can be obtained for the placement of the geotextiles.

The geotextile shall be laid on top of the block units and horizontally on the compacted backfill. The geotextile must be connected to the wall units by embedding the geotextile between the block courses. The geotextile must be anchored and pulled taut before the backfill is placed over the geotextile.

Slack in the geotextile at the wall unit connections shall be removed prior to the placement of fill above the reinforcement. It is recommended that uniform tensioning of all reinforcement layers be accomplished throughout the height of the wall. Slack in the geotextile reinforcement will result in undesirable movements of the wall which will require repair by the Contractor at no expense to the Owner.

PROTECTION OF WALL

The design of the wall is based on conditions and loads imposed on the wall upon completion of the project. Prior to project completion, the wall is vulnerable to damages caused by construction activity adjacent to the wall. Of particular concern is the use of grading equipment on the retained backfill at the top of the wall.

Track-type construction equipment shall not be operated directly on the reinforcing material. Turning of track-type vehicles on fill layers placed atop the reinforcing material shall be kept to a minimum so as to prevent tracks from displacing the fill and damaging the reinforcing material.

Rubber-tired equipment may pass directly on reinforcing material at slow speeds (less than 10 miles per hour). Sudden braking and sharp turning of vehicles shall be avoided.

Only equipment with a weight not exceeding 1 ton can be used in the 3-foot zone immediately behind the back face of the wall. Equipment exceeding this weight limit, including scrapers, high-lifts, dozers, bobcats, backhoes, motor graders, dump trucks, and pavers, must be kept a minimum of 3 feet from the back face of the wall to avoid overstressing the geotextile reinforcement and pushing the wall out of alignment. This restriction may require the use of hand labor to complete the wall. Equipment should be operated in a direction parallel to the alignment of the retaining wall. Equipment that is operated in a direction perpendicular to the wall face can push the wall out of alignment due to increased impact loading.

The surface of the wall backfill shall be graded at the end of each day of work to provide positive surface drainage away from the wall. Grading shall include proper contouring of fills in adjacent areas to prevent the flow of surface water into the select backfill work area.

Uncontrolled infiltration from heavy rains during construction can cause severe erosion and undermining of unit block walls, requiring their removal and reconstruction in some instances. Care must be exercised during construction to prevent the infiltration of surface water into the work area behind the wall. The Contractor shall control surface water during wall construction and make all necessary repairs caused by surface water at no additional expense to the Owner.

ALPENSTEIN®
RETAINING WALL SYSTEMS

Richard D. Laughlin, P.E.
MIDWEST TESTING, INC.
3377 Hollenberg Drive
Bridgeton, Missouri 63044
(314) 739-2727

KIRCHNER BLOCK AND BRICK
12901 St. Charles Rock Road
Bridgeton, Missouri 63044
(314) 291-3200

SPECIFICATIONS

ST. LOUIS COUNTY MASTER PLANS
ALPENSTEIN RETAINING WALLS

Sheet: 10 of 10

Date: 4/3/00